

# Vertical Freezer Lighting

## PEAK



# Vertical Freezer Lighting PEAK



# Vertical Freezer Lighting

## PEAK



- Bright and consistent illuminance for vending machine
- Less heat radiation, more energy saving
- Lifetime: 50,000hrs (ta=35 C)
- IP rating: IP65
- Ta:-25 C~35 C
- Material: PC



### Dimensions: (mm)

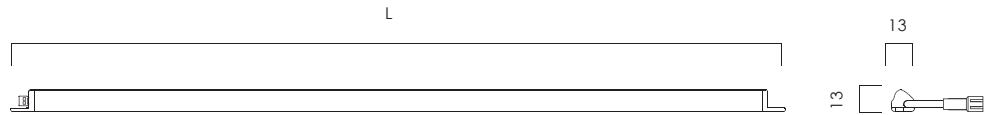

### Wiring Diagram

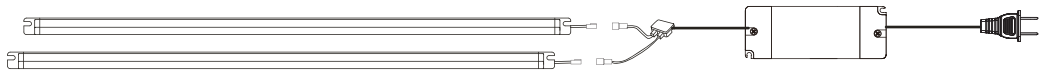

### Specialized Candlepower Distribution

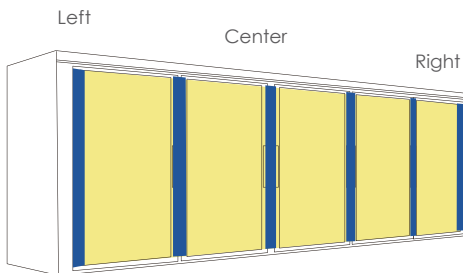
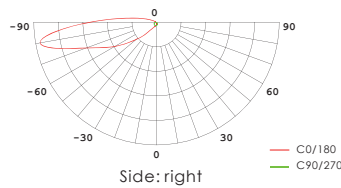
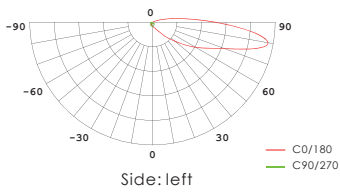

Spacing Distribution of Illuminance

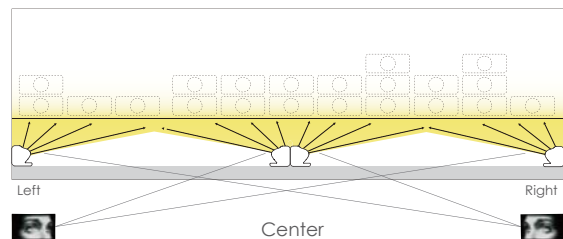

Anti-glare design

# Vertical Freezer Lighting

## PEAK

### Specifications :

Model	Input Voltage <sup>(1)</sup> (V)	frequency (HZ)	Power Factor <sup>(2)</sup>	power <sup>(1)</sup> (W)	CCT <sup>(3)</sup> (K)	Ra <sup>(4)</sup> (Typ.)	Beam Angle <sup>(5)</sup>	Luminous Flux <sup>(6)</sup> (lm)	Luminaire efficacy <sup>(7)</sup> (lm/w)	Length (mm)
PEAK-L28-24V	24	-	1	5.6	3000 4000	85	40°	560	100	570
PEAK-L28-24V-1	24	-	1	5.6	3000 4000	85	40°	560	100	570
PEAK-L42-24V	24	-	1	8.4	3000 4000	85	40°	840	100	890
PEAK-L42-24V-1	24	-	1	8.4	3000 4000	85	40°	840	100	890
PEAK-L56-24V	24	-	1	11.2	3000 4000	85	40°	1120	100	1180
PEAK-L56-24V-1	24	-	1	11.2	3000 4000	85	40°	1120	100	1180
PEAK-L70-24V	24	-	1	16	3000 4000	85	40°	1550	97	1680
PEAK-L70-24V-1	24	-	1	16	3000 4000	85	40°	1550	97	1680
PEAK LO-L70-24V	24	-	1	6	3000 4000	85	40°	720	120	1680
PEAK LO-L70-24V-1	24	-	1	6	3000 4000	85	40°	720	120	1680

[1]: Measurement precision for input voltage/current /power +/- 10%.

[2]: Minimum power factor is rated value - 0.05.

[3]: Comply with ANSI C78.377, Meat color is available upon orders, please contact sales for more information.



[4]: Minimum Ra(TYP.) is rated value - 2.

[5]: Beam angle ≤20°, measurement precision +/- 20%; beam angle >20°, measurement precision +/- 15%.

[6]: Minimum Luminous flux is 90% of rated value.

[7]: Minimum Luminaire efficacy is 90% of rated value.

### Accessories :

Order No.	Description	Length(mm)	Weight(g)
	 <p>Power-in cable x1</p>	1500	-
	 <p>Model: SLT30-24VLG-Es Matching driver, max. 30W. Input: 220-240VAC, 1500mm cable +plug Output: 24VDC 4-way splitter JB-4A + 150mm cable.</p>	-	-

\*Note: For alternative driver configurations, please contact our sales department.

### Certification and Safety :



Protection class: IP65

### Standards:

EN60598-1, EN55015, EN62031, EN62471, EN 60335-2-89  
Corresponding to IEC/EN60335-2-89 ANNEX BB, IEC/EN60335-2-24 ANNEX CC  
Suitable for use in commercial refrigerator with R290/R600a  
Correspond to IEC/EN60335-1: Clause 8, 15, 16, 19, 22.42, 29 & 30

# Vertical Freezer Lighting

## PEAK

### Spacing Distribution of Illuminance(unit:lx)

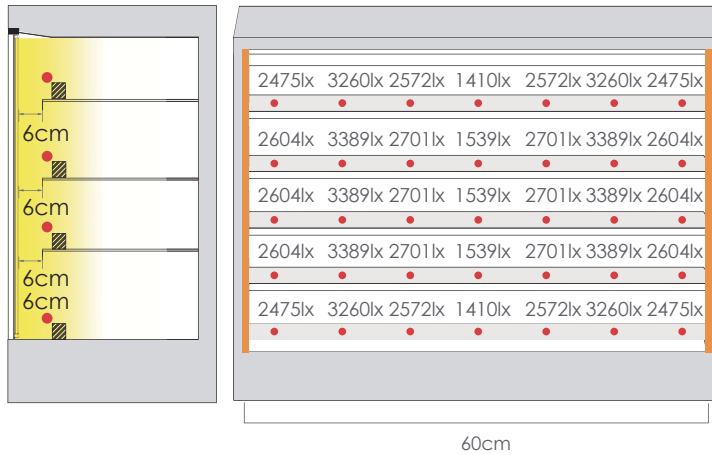

### Installation

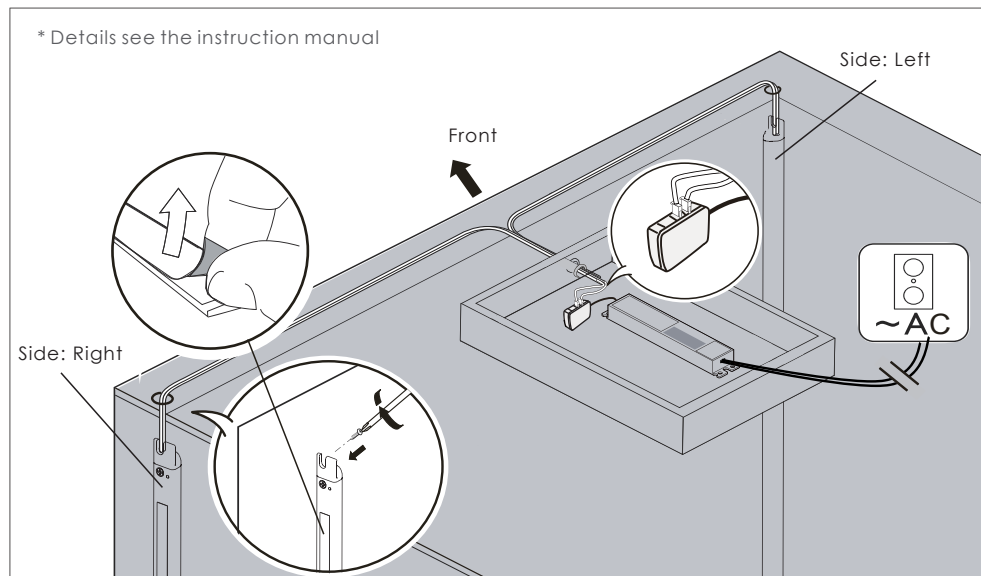
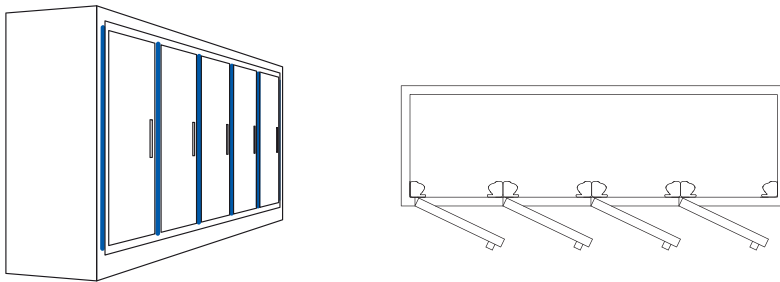

Other installation methods can be customized.