

HIOKI

New

DIGITAL MULTIMETER DT4200 Series

DMM / Testers



Super Fast Response Rate and Safety Features
Take Professional Testing to a Higher Level

Made in Japan for rock-solid quality.



GOOD
DESIGN
AWARD
2013



Hazard 1 Prevent unavoidable debris from shorting the measurement target and causing an accident.



The DT4255's voltage input terminals incorporate a protective fuse so that contamination of the instrument's internal components with iron powder or other particulate matter will not result in an internal short-circuit. The fuse can be replaced easily on site.

Hazard 2 Continued high input may result in major accidents such as fire.



To prevent an accident, a warning function immediately notifies the operator if the DMM receives excessively high input.

*Red screen available on high-end models only.

Hazard 3 Wrong insertion may lead to short-circuits.



A range: Only the A and COM terminal inlets open.
V range: Only the V and COM terminal inlets open.

The DT4281 and DT4282 use terminal shutters to keep probes from being inserted into the wrong inlets. The shutters block whichever terminal is not being used based on the selected measurement function.

Hazard 4 Mistakenly measuring voltage using the current range may lead to a short-circuit.



The DT4281, DT4253, DT4255, and DT4256 eliminate the root cause of such accidents by providing clamp-on sensor-based current measurement functionality instead of using conventional probes.



Safe testers that protect workers from dangerous accidents

Engineered based on extensive customer feedback, the Hioki Digital Multimeter DT4200 series delivers the design and quality needed in order to ensure safety in field measurement.

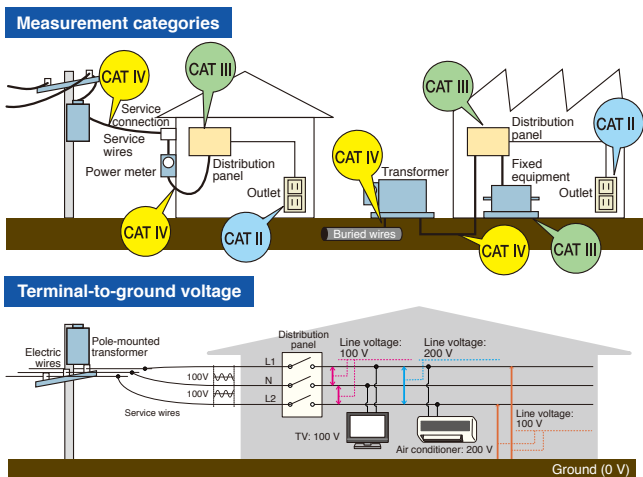

Safe measurement requires use of an instrument that suits the measurement location.

To ensure operators' ability to use measuring instruments safely, IEC 61010 classifies the locations in which instruments are used into a series of safety-based measurement categories (ranging from CAT II to CAT IV). Using an instrument that does not satisfy the required safety level can lead to an electrical accident.

CAT IV 600 V Terminal-to-ground voltage Measurement category suited to the location of use

High-end models	CAT III 1000 V / CAT IV 600 V
Standard models	CAT III 1000 V / CAT IV 600 V
Pocket models	CAT III 600 V / CAT IV 300 V



Designed and manufactured in Japan to ensure high quality and guaranteed with a 3-year warranty for peace of mind

All development, design, and manufacturing processes for almost all Hioki digital multimeters are carried out at our Head Office in Nagano Prefecture. Some of the industry's most advanced technological capabilities enable us to deliver products of the highest possible quality.





Field-Proven Strength and Usability

DT4200 series

Robust design capable of withstanding a drop from a height of 1 m onto concrete



Drop tester

To test our products' ability to withstand mechanical shock, we repeatedly drop them from a height of at least 1 m until they break. This drop-testing regime leads to more robust products by fostering a series of design improvements.



Preventing instrument failure by keeping out dust



If dust gets into the instrument's enclosure, it can cause the device to fail. Since dust can get into the instrument especially easily through the gap around the rotary switch, the DT4200 series incorporates a dust-proof part known as an O-ring where the rotary switch is mounted to improve the device's dust resistance.

Fast, accurate measurement of the output voltage on the secondary side of an inverter

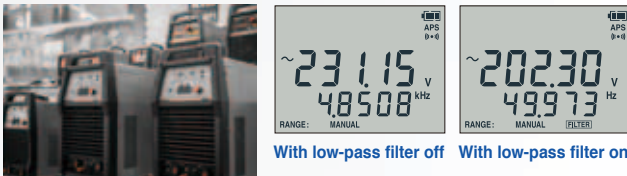

With low-pass filter off With low-pass filter on

The DT series can accurately measure the voltage on the secondary side of an inverter, just like a power meter. Its low-pass filter rejects harmonic components so that the fundamental wave can be isolated and accurately measured.

True RMS measurement for accurate measurement of even distorted current waveforms

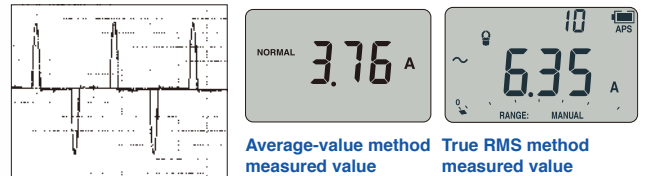

Average-value method
measured value

True RMS method
measured value

Current waveforms are often distorted, causing the average-value and true RMS measurement methods to yield different results. To obtain accurate readings, RMS measurement is indispensable.

Outstanding viewing angle so display is easy to read at an angle or even in a dim location



The DT4200 series features a display with a wide viewing angle and a backlight function so that it's easy to read, even when you can't view the screen from the front or when making measurements in a dim location.

Rotary switch that's easy to operate even when wearing gloves



The DT4200's rotary switch is designed to be easy to turn even when wearing thick work gloves, for example while working in hazardous measurement locations or harsh conditions.

Outstanding hands-free ease of use in the field when working with numerous measurement locations



Secure the instrument on the wall so that you don't have to hold it.



The display automatically stops once the measured value stabilizes.



Press the MEM key to save measured values in the instrument's internal memory.

It's hard to carry out work tasks smoothly when you're juggling a measuring instrument, probes, recording paper, and other supplies. Field concerns like these are resolved by the DT4200's magnetic strap, auto-hold function, and ability to save results in its internal memory. These capabilities boost work efficiency and help reduce work times.

*The auto-hold function is available exclusively in high-end and standard models. The ability to save results in internal memory is available exclusively in high-end models.

Extensive selection of probe tips that you can choose based on the measurement location, improving ease of measurement



With screw terminals



In deep-set locations that can't be reached with other probes



For clamping around the target busbar

With the DT4200, you can choose the probe type that best suits your measurement location, making it possible to measure in areas that can't be reached with conventional probes and busbars that you wish to clamp between probes.

*Compatible probe tips vary with the DMM model. Please see page 16. The optional Connection Cable L4930 is required in order to use the probes shown at the left.



High-end models

Featuring high accuracy, extensive additional functionality, and a broad range of measurement parameters

DCV typical accuracy: $\pm 0.025\%$ rdg. ± 2 dgt.

Measurement categories: CAT III (1000 V) / CAT IV (600 V)



For electrical work in the field

DT4281

Designed for maximum safety in the field when measuring current with clamp-on sensors.

DC voltage	60.000 mV to 1000.0 V
AC voltage	60.000 mV to 1000.0 V
DC + AC voltage	6.000 V to 1000.0 V
DC current	600.00 μ A to 600.00 mA
AC current	600.00 μ A to 600.00 mA
AC clamp-on measurement	Frequency
Resistance	Continuity check
Temperature	Diode test
Capacitance	Conductance
AC/DC automatic detection	Voltage detection function



For laboratory and research use

DT4282

Designed for use in laboratories and R&D applications where you wish to measure a wide variety of parameters.

DC voltage	60.000 mV to 1000.0 V
AC voltage	60.000 mV to 1000.0 V
DC + AC voltage	6.000 V to 1000.0 V
DC current	600.00 μ A to 10.000 A
AC current	600.00 μ A to 10.000 A
AC clamp-on measurement	Frequency
Resistance	Continuity check
Temperature	Diode test
Capacitance	Conductance
AC/DC automatic detection	Voltage detection function

● Supported measurement parameter ● Supported measurement parameter (with model-specific variations) ● Unsupported measurement parameter

*The range figures given indicate the instrument's measurement ranges (not the range of measurable values).

Applications



Magnetic strap frees both hands for work

Using the magnetic strap (option)

By using the magnetic strap to secure the instrument to the wall, you can free both hands so that you can more easily record measured values, significantly boosting work efficiency.



Automatically hold display values and save results with one touch to the DMM's internal memory

The display is automatically held once the measured value stabilizes. You can save measurement results to the instrument's internal memory simply by pressing the MEM key, making it easy to read and record values during inspection work.



Manage measurement data on a computer

Using the Communication Package DT4900-01 (option)

Measurement results can be downloaded to a computer via a USB connection. Once downloaded, you can save them as a file (text format) or display them as a graph using the desired interval. Results can also be sent in real time while measurement is ongoing.

*The computer and multimeter are electrically isolated by means of optical communications so that data can be sent with peace of mind.



Measure output voltage on the secondary sides of inverters

Accurately measure the fundamental wave alone by eliminating harmonic components with the DMM's low-pass filter function.

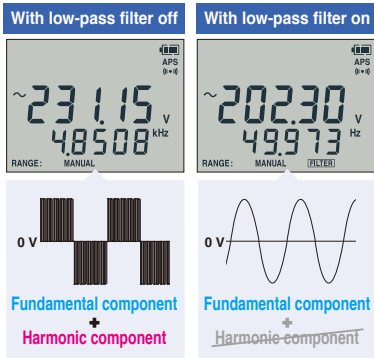

Ripple voltage confirmation of DC charging systems

Peak value measurement / DC + AC voltage measurement

High-end models can detect ripple voltage with a superposed DC signal.

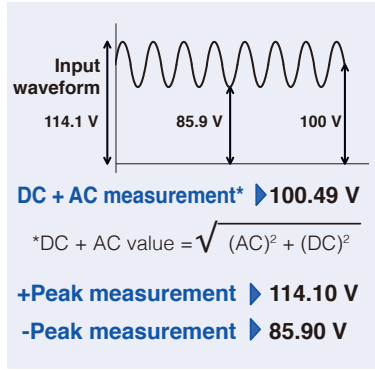

Percentage display for instrumentation signal measurement

4 to 20 mA / 0 to 20 mA percentage-equivalent display

You can check percentage-equivalent values.

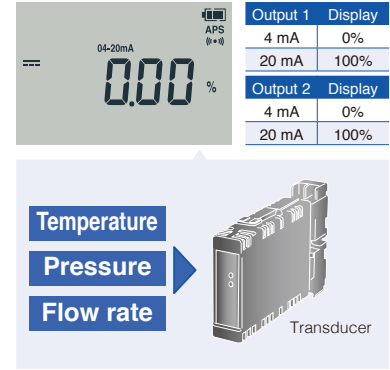

Measure very low currents used by gas-burning devices

DC μ A range

High-end models provide a DC 600.00 μ A range for measuring burner flame currents.

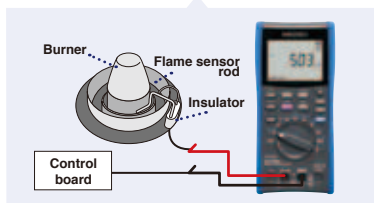

Intuitive notification of continuity check results and excessively high input with a red screen backlight and beep

High-end models notify the operator of continuity check results and excessively high input with a red screen backlight and beep, making it possible to check measurement results intuitively.

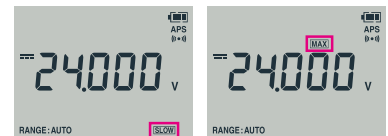

Display refresh rate

Change the display refresh speed to stabilize the display when performing measurement characterized by a high level of variability.

Maximum/minimum value display

Check the maximum and minimum measured values shown on the display after pressing the MAX/MIN button.

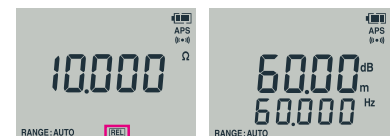

Relative display

View relative values using the display value before the relative function was enabled as the reference.

Decibel conversion

Convert the results of AC voltage measurement to a decibel value relative to a reference value and display the results (dbm/dbv).

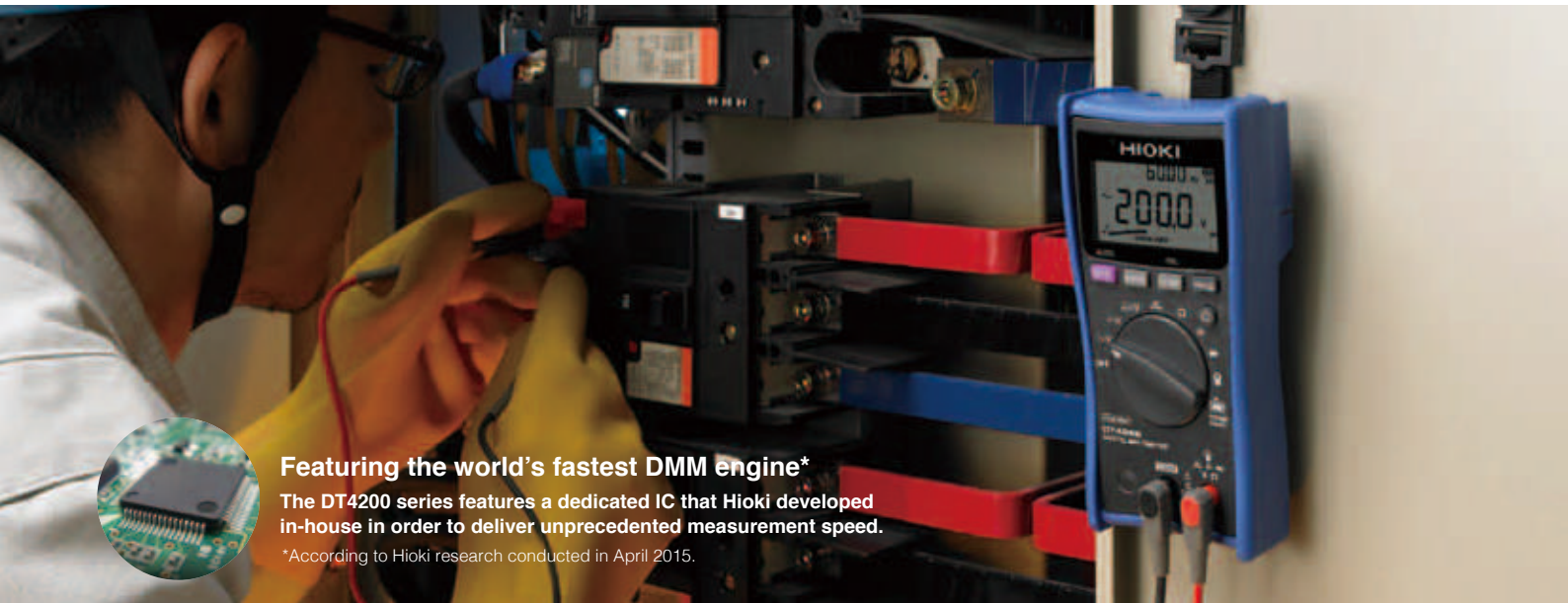

Featuring the world's fastest DMM engine*
 The DT4200 series features a dedicated IC that Hioki developed in-house in order to deliver unprecedented measurement speed.
 *According to Hioki research conducted in April 2015.

Standard models

Introducing a line of field-optimized instruments that can be chosen based on the application at hand

DCV typical accuracy: $\pm 0.3\%$ rdg. ± 3 dgt.

Measurement categories: CAT III (1000 V) / CAT IV (600 V)



For laboratory and research use

DT4252

For laboratories and R&D applications where you wish to measure a wide variety of parameters.



For instrumentation 4-20mA

DT4253

Measure instrumentation, air-conditioning equipment, and gas-burning devices.



Voltage measurement only model

DT4254

Measure photovoltaic modules and other high-voltage targets at up to 1700 V DC.



For electrical work in the field

DT4255

Designed for maximum safety with voltage measurement terminals that are protected by a fuse.



Multifunction model

DT4256

Delivers maximum functionality for use in a wide range of settings.

DC voltage	600.0 mV to 1000 V
AC voltage	6.000 V to 1000 V
DC + AC voltage	DT4281/4282 only
DC current	6.000 A to 10.00 A
AC current	6.000 A to 10.00 A
AC clamp-on measurement	Frequency
Resistance	Continuity check
Temperature	Diode test
Capacitance	Conductance
AC/DC automatic detection	Voltage detection function

DC voltage	600.0 mV to 1000 V
AC voltage	6.000 V to 1000 V
DC + AC voltage	DT4281/4282 only
DC current	60.00 μ A to 60.00 mA
AC current	n/a
AC clamp-on measurement	Frequency
Resistance	Continuity check
Temperature	Diode test
Capacitance	Conductance
AC/DC automatic detection	Voltage detection function

DC voltage	600.0 mV to 1500 V
AC voltage	6.000 V to 1000 V
DC + AC voltage	DT4261/4262 only
DC current	n/a
AC current	n/a
AC clamp-on measurement	Frequency
Resistance	Continuity check
Temperature	Diode test
Capacitance	Conductance
AC/DC automatic detection	Voltage detection function

DC voltage	600.0 mV to 1000 V
AC voltage	6.000 V to 1000 V
DC + AC voltage	DT4261/4262 only
DC current	n/a
AC current	n/a
AC clamp-on measurement	Frequency
Resistance	Continuity check
Temperature	Diode test
Capacitance	Conductance
AC/DC automatic detection	Voltage detection function

DC voltage	600.0 mV to 1000 V
AC voltage	6.000 V to 1000 V
DC + AC voltage	DT4281/4282 only
DC current	60.00 mA to 10.00 A
AC current	600.0 mA to 10.00 A
AC clamp-on measurement	Frequency
Resistance	Continuity check
Temperature	Diode test
Capacitance	Conductance
AC/DC automatic detection	Voltage detection function

● Supported measurement parameter ● Supported measurement parameter (with model-specific variations) ● Unsupported measurement parameter

*The range figures given indicate the instrument's measurement ranges (not the range of measurable values).

Applications



Magnetic strap and auto-hold function free up hands for easier work

Using the magnetic strap (option)

By using the magnetic strap to secure the instrument to the wall and the auto-hold function to automatically stop display values, you can free your hands, making it easier to record measured values and significantly boosting work efficiency.



Automatic switching of measurement in locations where AC and DC voltages are mixed

AC/DC voltage automatic detection (DT4253/54/55/56 only)

When making measurements in locations with both AC and DC voltages, automatic switching eliminates the need to operate the rotary switch and helps prevent measurement mistakes.



Use a computer in the field to save and check measured values

With the Communication Package DT4900-01 (option)

Measured values can be displayed in real time on a computer, and displayed values can be saved to a file (text format) or graphed at a user-specified interval.

*The computer and multimeter are electrically isolated by means of optical communications so that data can be sent with peace of mind.



Measure output voltage on the secondary sides of inverters

Accurately measure the fundamental wave by eliminating harmonic components with the DMM's low-pass filter function.

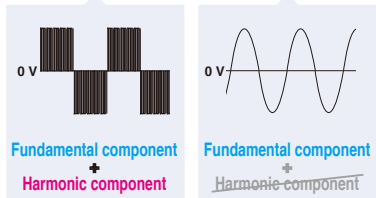
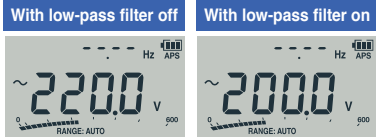

Test no-load voltage at megasolar installations

1700 V DC measurement (DT4254 only)

Model DT4254 can measure DC voltages up to 1700 V, enabling you to make no-load voltage inspections of megasolar installations.



Percentage display for instrumentation signal measurement

4 to 20 mA percentage-equivalent display (DT4253 only)

The standard models' dual display function lets you to simultaneously check measured values and percentage-equivalent values at a glance.



Polarity detection and notification

Certain standard models can detect a load voltage in excess of -10 V and notify the operator with a red LED and beep.

*DT4254/4255/4256 only.

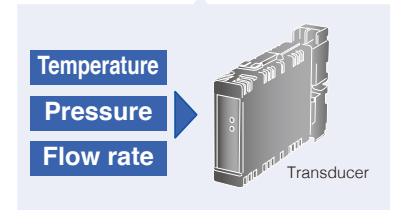

Measure very low currents used by gas-burning devices

DC μ A range (DT4253 only)

Model DT4253 provides a DC 60.00 μ A range for measuring burner flame currents.

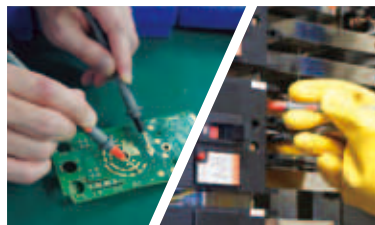
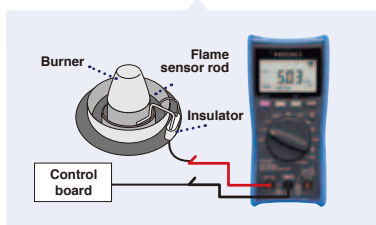

Intuitive notification of continuity check results and excessively high input with a red LED and beep

Standard models notify the operator of continuity check results and excessively high input with a red LED and beep, making it possible to check measurement results intuitively.

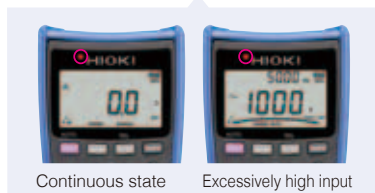

Thorough prevention of short-circuit accidents

Voltage measurement terminal fuse (DT4255 only)

When using the resistance measurement function, a protective circuit functions to prevent a short-circuit accident in the event of erroneous operation such as improperly supplying voltage input. Even if a short-circuit occurs inside the tester, a current-limiting resistor will limit any short-circuit current while a fast-blow fuse quickly and reliably disconnects the tester circuitry, preventing a short-circuit accident.

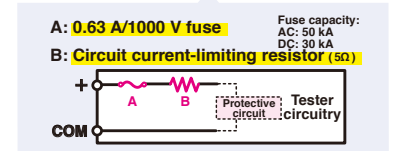

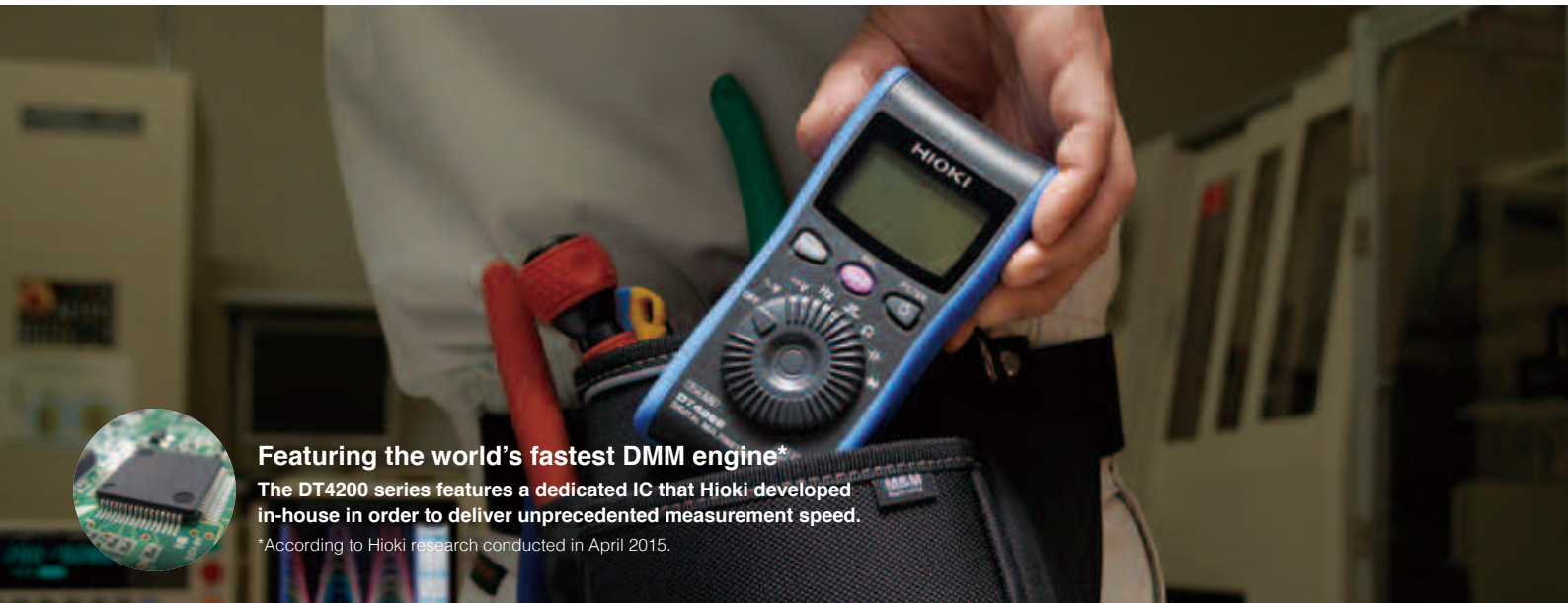

Featuring the world's fastest DMM engine*

The DT4200 series features a dedicated IC that Hioki developed in-house in order to deliver unprecedented measurement speed.

*According to Hioki research conducted in April 2015.

Pocket models

Featuring a compact body for ergonomic hold and a reliable, safe design

DCV typical accuracy: $\pm 0.5\%$ rdg. ± 5 dgt.

Measurement categories: CAT III (600 V) / CAT IV (300 V)



For electrical work in the field

DT4221

Delivering maximum field safety for workers whose principal use is voltage measurement.

DC voltage	600.0 mV to 600.0 V
AC voltage	6.000 V to 600.0 V
DC + AC voltage	DT4281/4282 only
DC current	n/a
AC current	n/a
AC clamp-on measurement	Frequency
Resistance	Continuity check
Temperature	Diode test
Capacitance	Conductance
AC/DC automatic detection	Voltage detection function



For multiple applications

DT4222

For laboratories and R&D applications to measure a wide variety of parameters.

DC voltage	600.0 mV to 600.0 V
AC voltage	6.000 V to 600.0 V
DC + AC voltage	DT4281/4282 only
DC current	n/a
AC current	n/a
AC clamp-on measurement	Frequency
Resistance	Continuity check
Temperature	Diode test
Capacitance	Conductance
AC/DC automatic detection	Voltage detection function

● Supported measurement parameter ● Supported measurement parameter (with model-specific variations) ● Unsupported measurement parameter

*The range figures given indicate the instrument's measurement ranges (not the range of measurable values).

Applications



Compact and lightweight design for outstanding ease of use

The small form factor fits in your hand perfectly and is easily stowable, making it convenient to transport to and from the field and boosting work efficiency. The lightweight design also ensures that pocket models are easy to work with.



Single AAA alkaline battery

Since the pocket models only use a single AAA alkaline battery that can be easily replaced, there's no need to carry a large number of spare batteries with you.

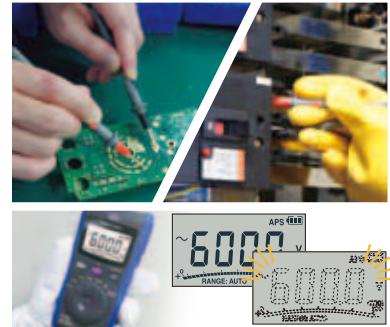

Intuitive notification of excessively high input with flashing screen

The pocket digital multimeters notify the operator of excessively high input by flashing the screen, making it possible to check measurement results intuitively.



Rear probe connections for superior screen visibility and easy storage

Since this design keeps cords from covering up the screen during measurement, you can read values at a glance. After use, probes can be stored on the rear of the instrument, facilitating a smooth start to the next measurement job.

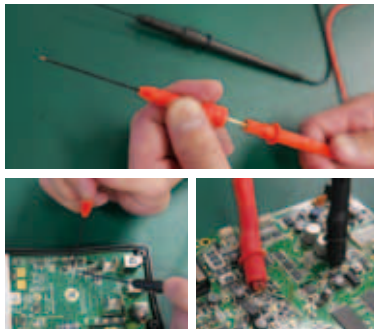

Switchable probe tips for different measurement locations

Probe tips can be switched to accommodate different measurement locations. This feature makes it easy to measure in areas that would otherwise be difficult or impossible to probe.



Safe enough for measuring voltage at distribution panels and service wires

Despite a compact body, the pocket models can be used to measure voltage at distribution panels and service wires in CAT III (600 V)/CAT IV (300 V) situations.

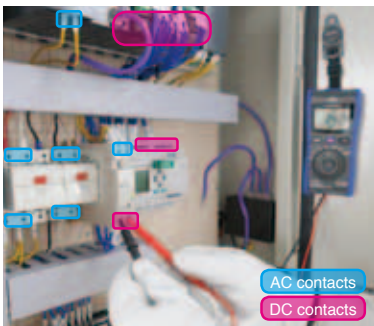

Automatic switching of measurement in locations where AC and DC voltages are mixed

AC/DC voltage automatic detection (DT4221 only)

When making measurements in locations with both AC and DC voltages, automatic switching eliminates the need to operate the rotary switch and helps prevent measurement mistakes.

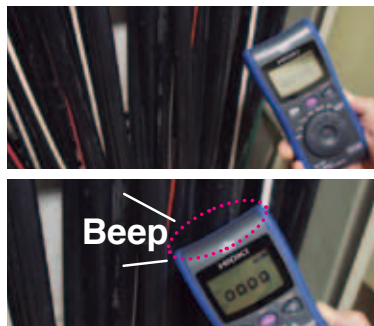

Detect voltage simply by holding the instrument against a wire

Voltage detection function (DT4221 only)

Easily detect voltage with the built-in sensor. Results are communicated with a beep.

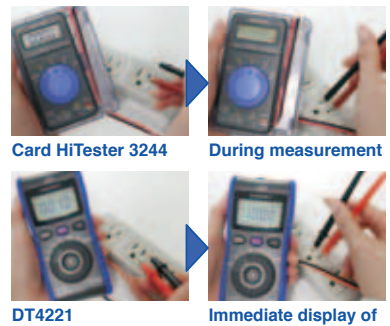

Card HiTester 3244

During measurement

DT4221

Immediate display of measurement results

Fast measurement for outstanding ease of use

Measured values are displayed quickly to facilitate quick testing. The difference is clear when you compare the measurement speed with that of the Hioki Card HITESTER 3244-60.

DT4200 Series Basic Comparison



Basic Characteristics												
True RMS	Yes			Yes			Yes					
DCV basic accuracy	±0.025 %rdg. ±2 dgt.			±0.3 %rdg. ±5 dgt.			±0.3 %rdg. ±3 dgt.					
Measurement items (Typical ranges are indicated; may not reflect maximum or minimum measurable signal)												
DC voltage	60 mV to 1000 V			600 mV to 1000 V			600 mV to 1500 V		600 mV to 1000 V			
AC voltage	60 mV to 1000 V			6 V to 1000 V						6 V to 600 V		
DCV + ACV	6 V to 1000 V			n/a						n/a		
DCA current	600 µA to 600 mA	600 µA to 10 A		6 A to 10 A	60 µA to 60 mA		n/a		60 mA to 10 A			
ACA current	600 µA to 600 mA	600 µA to 10 A		6 A to 10 A	n/a				600 mA to 10 A			
AC clamp	10 A to 1000 A	n/a		n/a		10 A to 1000 A		n/a		10 A to 1000 A		
Resistance	60 Ω to 600 MΩ			600 Ω to 60 MΩ			n/a		600 Ω to 60 MΩ		n/a	
Temperature	-40°C to 800°C			n/a		-40°C to 400°C		n/a				
Capacitance	1 nF to 100 mF			1 µF to 10 mF			n/a		1 µF to 10 mF		n/a	
Frequency	99 Hz to 500 kHz			99 Hz to 99 kHz						99 Hz to 9.9 kHz		
Continuity check	Yes			Yes		n/a		Yes		Yes		
Diode check	Yes			Yes		n/a		Yes		n/a		
Conductance	n/a		Yes		n/a				n/a			
Voltage detection	n/a			n/a			Yes			Yes		
Additional Functions												
AUTO AC/DCV	n/a			n/a		Yes				Yes		
Peak measurement	DC/AC			n/a						n/a		
Low-pass filter	Analog filter Cut-off : 630 Hz			Digital filter Pass-band : 100Hz/500Hz						Digital filter Pass-band : 100Hz/500Hz		
Display update setting	Yes			n/a						n/a		
Hold display value	AUTO / MANUAL			AUTO / MANUAL						MANUAL		
Max/Min value display	Yes			Yes						n/a		
Relative display	Yes			Yes						Yes		
Decibel conversion	Yes			n/a						n/a		
Percentage conversion display	Yes		n/a		Yes		n/a		n/a		n/a	
DC voltage polarity check	n/a			n/a			Yes				n/a	
Data storage												
Capacity	Max 400 data			n/a						n/a		
USB communication*1	Yes			Yes						n/a		
Operating time												
Continuous operating time	Approx. 100 hours*2			Approx. 130 hours						Approx. 40 hours		
Power supply	Alkaline (LR6) battery x4 / Manganese(R6P) battery x4			Alkaline (LR03) battery x4						Alkaline (LR03) battery x1		
Display												
Back light	Yes			Yes						Yes		
Dual display	Yes			Yes						n/a		
Bar graph display	n/a			Yes						Yes		
Safety												
Safety standard categories	CATIII1000 V / CATIV600 V			CATIII1000 V / CATIV600 V						CATIII600 V / CATIV300 V		
Mis-insertion prevention shutters	Yes			n/a						n/a		

*1. Requires optional DT4900-01 Communication Package

*2. When using four AA alkaline batteries

Glossary

Auto AC/DCV : Automatically detects and measures AC and DC voltage. | **Peak measurement** : After starting PEAK value measurement, check maximum and minimum instantaneous voltage and current values. | **Low-pass filter** : Cuts high frequency content to provide stable numerical values for measurement. | **Display update setting** : Reduces the display value update rate to stabilize measurements. | **Hold display value** : Manual: press the button to freeze the display. Auto: the display freezes automatically when the measurement value is stable. | **Max/Min value display** : Pressing the MAX/MIN button displays the maximum and minimum displayed measurement values. | **Relative display** : Pressing the REL button displays subsequent measurements as values relative to that displayed when the button was pressed. | **Decibel conversion** : Displays AC voltage measurements converted to decibel values (dbm/dbv) | **Percentage conversion display** : Displays 4 to 20 mA (or 0 to 20 mA) signals converted to 0 to 100% values. For the DT4253, only 4 to 20 mA.

High-End DT4281/DT4282

(Accuracy guaranteed for 1 year, Post-adjustment accuracy guaranteed for 1 year)

DC Voltage		
Range	Accuracy	Input Impedance
60.000 mV	±0.2 %rdg. ±25 dgt.	1 GΩ or more //100 pF or less
600.00 mV	±0.025 %rdg. ±5 dgt.	
6.0000 V	±0.025 %rdg. ±2 dgt.	11.0 MΩ±2% //100 pF or less
60.000 V		10.3 MΩ±2% //100 pF or less
600.00 V	±0.03 %rdg. ±2 dgt.	10.2 MΩ±2% //100 pF or less
1000.0 V		

AC Voltage						
Range	Accuracy					
	20 to 45 Hz	45 to 65 Hz	65 to 1 kHz	1 k to 10 kHz	10 k to 20 kHz	20 k to 100 kHz
60.000 mV	±1.3 %rdg.	±0.4 %rdg.	±0.6 %rdg.	±0.9 %rdg.	±1.5 %rdg.	±20 %rdg. ±80 dgt.
600.00 mV	±60 dgt.	±40 dgt.	±40 dgt.	±40 dgt.	±40 dgt.	±8 %rdg. ±80 dgt.
6.0000 V	±1 %rdg. ±60 dgt.	±0.2 %rdg. ±25 dgt.	±0.3 %rdg. ±25 dgt.	±0.4 %rdg. ±25 dgt.	±0.7 %rdg. ±40 dgt.	±3.5 %rdg. ±40 dgt.
60.000 V	Undefined					
600.00 V	Undefined	Undefined	Undefined	Undefined	Undefined	Undefined
1000.0 V	Undefined					

DCV + ACV Measurement						
Range	Accuracy					
	20 to 45 Hz	45 to 65 Hz	65 to 1 kHz	1 k to 10 kHz	10 k to 20 kHz	20 k to 100 kHz
6.0000 V	±1.2 %rdg. ±65 dgt.	±0.3 %rdg. ±30 dgt.	±0.4 %rdg. ±30 dgt.	±0.4 %rdg. ±30 dgt.	±1.5 %rdg. ±45 dgt.	±3.5 %rdg. ±125 dgt.
60.000 V	Undefined					
600.00 V	Undefined	Undefined	Undefined	Undefined	Undefined	Undefined
1000.0 V	Undefined					

Input impedance	1MΩ ± 4 %//100pF or less
Crest factor	3 or less (1.5 or less for the 1000.0V range)
Accuracy specification range	5% or more of each range With the filter ON, accuracy is defined only for frequencies 100Hz or less. Furthermore, 2% rdg. is added

DCA Measurement				*1 : DT4282 only
Range	Accuracy / Display update : SLOW	Accuracy / Display update : NORMAL	Shunt Resistance	
600.00 μA	±0.05 %rdg. ±5 dgt.	±0.05 %rdg. ±25 dgt.	101 Ω	
6000.0 μA		±0.05 %rdg. ±5 dgt.		
60.000 mA	±0.15 %rdg. ±5 dgt.	±0.05 %rdg. ±25 dgt.		1 Ω
600.00 mA	±0.2 %rdg. ±5 dgt.	±0.15 %rdg. ±5 dgt.	10m Ω	
6.0000 A ¹		±0.2 %rdg. ±25 dgt.		
10.000 A ¹		±0.2 %rdg. ±5 dgt.		

ACA Measurement						*1 : DT4282 only
Range	Accuracy					
	20 to 45 Hz	45 to 65 Hz	65 to 1 kHz	1 k to 10 kHz	10 k to 20 kHz	
600.00 μA	±1.0 %rdg. ±20 dgt.	±0.6 %rdg. ±20 dgt.	±0.6 %rdg. ±20 dgt.	±2 %rdg. ±20 dgt.	±4 %rdg. ±20 dgt.	
6000.0 μA	±1.0 %rdg. ±5 dgt.	±0.6 %rdg. ±5 dgt.	±0.6 %rdg. ±5 dgt.	±2 %rdg. ±5 dgt.	±4 %rdg. ±5 dgt.	
60.000 mA	±1.0 %rdg. ±20 dgt.	±0.6 %rdg. ±20 dgt.	±0.6 %rdg. ±20 dgt.	±1 %rdg. ±20 dgt.	±2 %rdg. ±20 dgt.	
600.00 mA	±1.0 %rdg. ±5 dgt.	±0.6 %rdg. ±5 dgt.	±0.6 %rdg. ±5 dgt.	±1.5 %rdg. ±10 dgt.	Undefined	
6.0000 A ¹	Undefined	±0.8 %rdg. ±20 dgt.	±0.8 %rdg. ±20 dgt.	Undefined	Undefined	
10.000 A ¹	Undefined	±0.8 %rdg. ±5 dgt.	±0.8 %rdg. ±5 dgt.	Undefined	Undefined	

Shunt resistance	μA Range 101Ω/ mA Range 1Ω/ A Range 10mΩ
Crest factor	3 or less (Note that it applies to 1/2 of the range.)
Accuracy specification range	Accuracy is not defined for measurements below 5% of range

Continuity Check			
Range	Accuracy	Measurement Current	Open-terminal Voltage
600.0 Ω	±0.5 %rdg. ±5 dgt.	640 μA ±10%	DC2.5 V or less
Continuity threshold	20Ω (default) /50Ω/ 100Ω/ 500Ω		

Diode Check			
Range	Accuracy	Measurement Current	Open-terminal Voltage
3.600 V	±0.1 %rdg. ±5 dgt.	1.2 mA or less	DC4.5 V or less
Forward threshold	0.15V/ 0.5V (default)/1V/ 1.5V/ 2V/ 2.5V/ 3V If the reading is lower than the threshold during the forward connection, a buzzer sounds and the red backlight turns on.		

AC Clamp (AC Current)			DT4281 only
Range	Accuracy		
	40 to 65 Hz	65 to 1 kHz	
10.00 A	±0.6 %rdg. ±2 dgt.	±0.9 %rdg. ±2 dgt.	
20.00 A	±0.6 %rdg. ±4 dgt.	±0.9 %rdg. ±4 dgt.	
50.00 A	±0.6 %rdg. ±10 dgt.	±0.9 %rdg. ±10 dgt.	
100.0 A	±0.6 %rdg. ±2 dgt.	±0.9 %rdg. ±2 dgt.	
200.0 A	±0.6 %rdg. ±4 dgt.	±0.9 %rdg. ±4 dgt.	
500.0 A	±0.6 %rdg. ±10 dgt.	±0.9 %rdg. ±10 dgt.	
1000 A	±0.6 %rdg. ±2 dgt.	±0.9 %rdg. ±2 dgt.	

The optional 9010-50, 9018-50, or 9132-50 CLAMP ON PROBE is used. Accuracy does not include the error of the clamp-on probe.
Crest factor 3 or less
Accuracy is not defined for measurements below 15% of range

Resistance Measurement			
Range	Accuracy	Measurement Current	Open-terminal Voltage
60.000 Ω	±0.3 %rdg. ±20 dgt.	640 μA ±10%	DC2.5 V or less
6000.00 Ω	±0.03 %rdg. ±10 dgt.		
6.0000 kΩ	±0.03 %rdg. ±2 dgt.	96 μA ±10%	
60.000 kΩ		9.3 μA ±10%	
600.00 kΩ		0.96 μA ±10%	
6.0000 MΩ	±0.15 %rdg. ±4 dgt.	96 nA ±10%	
60.00 MΩ	±1.5 %rdg. ±10 dgt.		
600.0 MΩ	±3.0 %rdg. ±20 dgt.		
	±8.0 %rdg. ±20 dgt.		

Conductance (nS)				DT4282 only
Range	Accuracy	Measurement Current	Open-circuit Voltage	
600.00 nS	±1.5 %rdg. ±10 dgt.	96 nA ±10%	DC2.5 V or less	

Accuracy is defined for humidity 60% RH or less. Accuracy is defined for the range 20nS or more. In the case of 300 nS or more, ±20 dgt. is added

Capacitance Measurement			
Range	Accuracy	Measurement Current	Open-circuit Voltage
1.000 nF	±1 %rdg. ±20 dgt.	32 μA ±10%	DC2.5 V or less
10.00 nF	±1 %rdg. ±5 dgt.		
100.0 nF			
1.000 μF	±2 %rdg. ±5 dgt.	680 μA ±20%	DC3.1 V or less
10.00 μF			
100.0 μF			DC2.1 V or less
1.000 mF			
10.00 mF			
100.0 mF	±2 %rdg. ±20 dgt.		

Temperature		
Thermocouple Type	Range	Accuracy
K	-40.0 to 800.0 °C (-40.0 to 1472.0°F)	±0.5 %rdg. ±3 °C (5.4°F)

The optional K Thermocouple DT4910 is used. Accuracy does not include the error of the K thermocouple

Frequency (For AC V, DC+AC V, AC μA, AC mA, AC A)	
Range	Accuracy
99.999 Hz	±0.005 %rdg. +3 dgt.
999.99 Hz	
9.9999 kHz	
99.999 kHz	±0.005 %rdg. +3 dgt.
500.00 kHz	

Measurement range	0.5Hz or more ([----] is displayed when frequency is less than 0.5Hz)
Pulse width	1μs or more (DUTY ratio is 50%)
With the filter ON, accuracy is defined only for frequencies 100Hz or less. (For ACV, DC+ACV)	

Peak Measurement (For AC V, DC V, DC+AC V, Clamp, DC μA, DC mA, DC A, AC μA, AC mA, AC A)		
Main measurement	Signal width	Accuracy
DCV	4ms or more (single)	±2.0 %rdg. ±40 dgt.
	1ms or more (repeated)	±2.0 %rdg. ±100 dgt.
Other than DCV	1ms or more (single)	±2.0 %rdg. ±40 dgt.
	250μs or more (repeated)	±2.0 %rdg. ±100 dgt.

Decibel Conversion Measurement : Standard impedance (dBm)	
4/8/16/32/50/75/93/110/125/135/150/200/250/300/500/600/800/900/1000/1200 Ω (default : 600 Ω)	

General Specifications

Durability	
Drop proof	YES
Operating temperature and humidity*1	-15°C to 55°C
Storage temperature and humidity*2	-30°C to 60°C
Dielectric strength	AC8.54kV (Between all input terminals and case)
Applicable standards	Safety : EN61010, EMC: EN61326, Waterproof and dustproof: IP40

*1 : -15°C to 55°C (5°F to 131°F), Up to 40°C (104°F): at 80%RH or less (non-condensating),
 40°C to 45°C (104°F to 113°F): at 60%RH or less (non-condensating),
 45°C to 55°C (113°F to 131°F): at 50%RH or less (non-condensating)
 *2 : 80%RH or less (non-condensating)

Dimensions/Mass
93mm(W)×197mm(H)×53mm(D)(3.66"W 7.76"H 2.09"D Inch) / 650g (including batteries) (23 oz.)

Safety	
Maximum rated voltage between input terminals and ground	CATIII1000 V/ CATIV600 V
Maximum rated voltage between terminals	Between the V and COM terminals : 1000 V DC/AC
Maximum rated current between terminals	Between the mA and COM terminals : 600mA DC/600mA AC Between the A and COM terminals : 10A DC/10A AC

Accessories

TEST LEAD L9207-10 , Instruction Manual, LR6 alkaline battery×4

Standard DT4252/DT4253/DT4254/DT4255/DT4256

(Accuracy guaranteed for 1 year, Post-adjustment accuracy guaranteed for 1 year)

DC Voltage		*1 : DT4252 only	*2 : DT4254 only
Range	Accuracy	Input Impedance	
High precision 600mV range ¹	±0.2 %rdg. ±5 dgt.	10.2 MΩ ± 1.5 %	
600.0 mV	±0.5 %rdg. ±5 dgt.	11.2 MΩ ± 2.0 %	
6.000 V	±0.3 %rdg. ±3 dgt.	10.3 MΩ ± 2.0 %	
60.00 V		10.2 MΩ ± 1.5 %	
600.0 V		10.2 MΩ ± 1.5 %	
1000 V	±0.3 %rdg. ±3 dgt.	10.2 MΩ ± 1.5 %	
1500 V ²	±0.3 %rdg. ±3 dgt.	10.2 MΩ ± 1.5 %	

AC Voltage			
Range	Accuracy		Input Impedance
	40 to 500 Hz	500 or more to 1kHz	
6.000V	±0.9 %rdg. ±3 dgt.	±1.8 %rdg. ±3 dgt.	11.2 MΩ ± 2.0%/100 pF or less
60.00V			10.3 MΩ ± 2.0%/100 or less
600.0V			10.2 MΩ ± 1.5%/100 or less
1000V			10.2 MΩ ± 1.5%/100 or less

AUTO V (Identification) DT4253/54/55/56 only			
Range	Accuracy		Input Impedance
	DC, 40 to 500 Hz	500 or more to 1kHz	
600.0 V	±2.0 %rdg. ±3 dgt.	±4.0 %rdg. ±3 dgt.	900 kΩ ± 20% 1800 kΩ ± 20% ¹
Crest factor	3 up to 4000 counts and reduces linearly to 2 at 6000 counts.		
Accuracy specification range	For ACV, minimum 1% of range; add ±5 dgt. when measuring at or below 5% of range With the filter ON, the accuracy is not specified at 100Hz/500Hz or more		

*1 : DT4254

DCA Measurement DT4252/53/56 only		
Range	Accuracy	Input Impedance
● 60.00 μA	±0.8 %rdg. ±5 dgt.	1 kΩ±5 %
● 600.0 μA	±0.8 %rdg. ±5 dgt.	1 kΩ±5 %
● 6.000 mA	±0.8 %rdg. ±5 dgt.	15 Ω±40 %
● 60.00 mA	±0.8 %rdg. ±5 dgt. ¹	15 Ω±40 % ¹
● 600.0 mA	±0.9 %rdg. ±5 dgt.	35 mΩ±30 %
● 6.000 A	±0.9 %rdg. ±3 dgt. ²	35 mΩ±30 %
● 10.00 A	±0.9 %rdg. ±3 dgt. ²	35 mΩ±30 %

● : DT4252 ● : DT4253 ● : DT4256

*1 : DT4256 : ±1.8 %rdg. ±15 dgt. Input Impedance : 35 mΩ±30 %

*2 : DT4252 : ±0.9 %rdg. ±5 dgt.

ACA Measurement DT4252/56 only			
Range	Accuracy		Input Impedance
	40 to 500 Hz	500 or more to 1kHz	
600.0 mA ¹	±1.4 %rdg. ±5 dgt.	±1.8 %rdg. ±5 dgt.	35 mΩ±30 %
6.000 A	±1.4 %rdg. ±3 dgt.	±1.8 %rdg. ±3 dgt.	35 mΩ±30 %
10.00 A	±1.4 %rdg. ±3 dgt.	±1.8 %rdg. ±3 dgt.	35 mΩ±30 %

Crest factor 3 up to 4000 counts and reduces linearly to 2 at 6000 counts.

Accuracy specification range Minimum 1% of range; add ±5 dgt. when measuring 300 counts or less

*1 : DT4256 only

Electric Charge DT4254/55/56 only		
Range	Detection voltage range	Detection Target Frequency
Hi	AC40 V to AC600 V	50 Hz / 60 Hz
Lo	AC80 V to AC600 V	

During voltage detection, a continuous buzzer sounds and the red LED lights up.

Continuity Check		DT4252/53/55/56 only	
Range	Accuracy	Measurement Current	Open-terminal Voltage
600.0 Ω	±0.7 %rdg. ±5 dgt.	Approx. 200 μA	DC1.8 V or less
Continuity ON threshold	Approx. 25Ω or less (continuous buzzer sound, red LED lights)		
Continuity OFF threshold	Approx. 245Ω or more		

Diode Check DT4252/53/55/56 only			
Range	Accuracy	Measurement Current	Open-terminal Voltage
1.500 V	±0.5 %rdg. ±5 dgt. ¹	Approx. 0.5 mA	DC5.0 V or less
Forward threshold	Buzzer sounds intermittently at 0.15V to 1.5V, the red LED flashes		

*1 : DT4255 : ±0.5 %rdg. ±8 dgt.

AC Clamp (AC Current) DT4253/55/56 only	
Range	Accuracy
10.00 A	±0.9 %rdg. ±3 dgt.
20.00 A	
50.0 A	
100.0 A	
200.0 A	
500 A	
1000 A	

The optional 9010-50, 9018-50, or 9132-50 CLAMP ON PROBE is used. Accuracy does not include the error of the clamp-on probe.

Crest factor	3 or less
Accuracy specification range	Minimum 1% of range; add ±5 dgt. when measuring at or below 5% of range

Resistance Measurement DT4252/53/55/56 only			
Range	Accuracy	Measurement Current	Open-terminal Voltage
600.0 Ω	±0.7 %rdg. ±5 dgt.	Approx. 200 μA	DC1.8 V or less
6.000 kΩ	±0.7 %rdg. ±3 dgt. ¹	Approx. 100 μA	
60.00 kΩ		Approx. 10 μA	
600.0 kΩ		Approx. 1 μA	
6.000 MΩ	±0.9 %rdg. ±3 dgt. ¹	Approx. 100 nA	
60.00 MΩ	±1.5 %rdg. ±3 dgt. ¹	Approx. 10 nA	

Accuracy guarantee condition After zero adjustment has been performed

*1 : DT4252/4253 : ±5dgt.

Capacitance Measurement DT4252/53/55/56 only			
Range	Accuracy	Measurement Current	Open-terminal Voltage
1.000 μF	±1.9 %rdg. ±5 dgt.	Approx. 10 n/100 n/1 μA	DC1.8 V or less
10.00 μF		Approx. 100 n/1 μ/10 μA	
100.0 μF		Approx. 1 μ/10 μ/100 μA	
1.000 mF	Approx. 10 μ/100 μ/200 μA		
10.00 mF	±5.0 %rdg. ±20 dgt.	Approx. 100 μ/200 μA	

Temperature DT4253 only		
Thermocouple Type	Range	Accuracy
K	-40.0 to 400.0 °C	±0.5 %rdg. ±2 °C

The optional K Thermocouple DT4910 is used. Accuracy does not include the error of the K thermocouple

Frequency	
Range	Accuracy
99.99 Hz	±0.1 %rdg. +1 dgt.
999.9 Hz	
9.999 kHz	
99.99 kHz (V AC Only)	

General Specifications

Durability	
Drop proof	YES
Operating temperature and humidity*1	-25°C to 65°C(DT4254/4255/4256) -10°C to 50°C(DT4252/4253)
Storage temperature and humidity*2	-30°C to 70°C(DT4254/4255/4256) -30°C to 60°C(DT4252/4253)
Dielectric strength	AC8.54 kV (Between all input terminals and case)
Applicable standards	Safety : EN61010, EMC: EN61326, Waterproof and dustproof: IP42

*1 : -10°C to 50°C(14°F to 122°F), Up to 40°C(104°F): at 80%RH or less(non-condensating),
40°C to 45°C (104°F to 113°F): at 60%RH or less(non-condensating),
45°C to 55°C (113°F to 131°F): at 50%RH or less (non-condensating)
*1 : Up to 40°C(104°F): at 80%RH or less(non-condensating),
40°C to 65°C (104°F to 149°F): reduces linearly 80%rh to 25%rh or less
*2 : 80%RH or less (non-condensating)

Dimensions/Mass
84mm(W)×174mm(H)×52mm(D)(3.31"W 6.85"H 2.05"D) 390g (including batteries and holster) (13.8 oz.)

Pocket DT4221/DT4222

(Accuracy guaranteed for 1 year, Post-adjustment accuracy guaranteed for 1 year)

DC Voltage		
Range	Accuracy	Input Impedance
600.0 mV	±0.5 %rdg. ±5 dgt.	11.2 MΩ ± 2.0 %
6.000 V		
60.00 V		10.3 MΩ ± 2.0 %
600.0 V		

AC Voltage			
Range	Accuracy		Input Impedance
	40 to 500Hz	500 or more to 1kHz	
6.000 V	±1.0 %rdg. ±3 dgt.	±2.5 %rdg. ±3 dgt.	11.2 MΩ ± 2.0%/100 pF or less
60.00 V		±2.0 %rdg. ±3 dgt.	10.3 MΩ ± 2.0%/100 pF or less
600.0 V			10.2 MΩ ± 1.5%/100 pF or less

Crest factor 3 up to 4000 counts and reduces linearly to 2 at 6000 counts.
Accuracy specification range For ACV, minimum 1% of range; add ±5 dgt. when measuring at or below 5% of range
With the filter ON, the accuracy is not specified in 100Hz/500Hz or more

AUTO V (Identification) DT4221 only			
Range	Accuracy		Input Impedance
	DC, 40 to 500 Hz	500 or more to 1kHz	
600.0 V	±2.0 %rdg. ±3 dgt.	±4.0 %rdg. ±3 dgt.	900 kΩ ± 20 %

Crest factor 3 up to 4000 counts and reduces linearly to 2 at 6000 counts.
Accuracy specification range For ACV, minimum 1% of range; add ±5 dgt. when measuring at or below 5% of range
With the filter ON, the accuracy is not specified in 100Hz/500Hz or more

Electric Charge DT4221 only	
Detection Voltage Range	Detection Target Frequency
AC80 V to AC600 V	50 Hz / 60 Hz

During voltage detection, a continuous buzzer sounds.

Continuity Check			
Range	Accuracy	Measurement Current	Open-terminal Voltage
600.0 Ω	±1.0 %rdg. ±5 dgt.	Approx. 200 μA	DC1.8 V or less
Continuity ON threshold	Approx. 25Ω or less (continuous buzzer sound)		
Continuity OFF threshold	Approx.245Ω or more		

General Specifications

Durability	
Drop proof	YES
Operating temperature and humidity*1	-10°C to 50°C
Storage temperature and humidity*2	-30°C to 60°C
Dielectric strength	AC7.06kV (Between all input terminals and case)
Applicable standards	Safety : EN61010, EMC: EN61326, Waterproof and dustproof: IP42

*1 : -10°C to 50°C(14°F to 122°F), Up to 40°C(104°F): at 80%RH or less(non-condensating),
40°C to 45°C (104°F to 113°F): at 60%RH or less(non-condensating),
45°C to 50°C (113°F to 122°F): at 50%RH or less (non-condensating)
*2 : 80%RH or less (non-condensating)

Dimensions/Mass
72mm(W)×149mm(H)×38mm(D) (2.83"W 5.87"H 1.50"D) 190g (including batteries and holster) (6.7 oz.)

Safety	
Maximum rated voltage between input terminals and ground	CATIII1000 V/ CATIV600 V
Maximum rated voltage between terminals	Between the V and COM terminals : DC1000 V/ AC1000 V*1
Maximum rated current between terminals	Between the A and COM terminals : DC10 A/ AC10 A (DT4252/DT4256) Between the μA ,mAand COM terminals : DC60 mA (DT4253 only)

*1 : DT4254 ---- DC1700 V/AC1000 V

Accessories

TEST LEAD L9207-10 / Instruction Manual / LR03 Alkaline battery×4
Holster (attached to the instrument, with a test lead holder)

Diode Check DT4222 only			
Range	Accuracy	Measurement Current	Open-terminal Voltage
1.500 V	±0.9 %rdg. ±5 dgt.	Approx.0.5 mA	DC2.5 V or less

Resistance Measurement DT4222 only			
Range	Accuracy	Measurement Current	Open-terminal Voltage
600.0 Ω	±0.9 %rdg. ±5 dgt.	Approx.200 μA	DC1.8 V or less
6.000 kΩ		Approx.100 μA	
60.00 kΩ		Approx.10 μA	
600.0 kΩ		Approx.1 μA	
6.000 MΩ		Approx.100 nA	
60.00 MΩ		Approx.10 nA	

Accuracy guarantee condition After zero adjustment has been performed

Capacitance Measurement DT4222 only			
Range	Accuracy	Measurement Current	Open-terminal Voltage
1.000 μF	±1.9 %rdg. ±5 dgt.	Approx.10 n/100 n/1 μA	DC1.8 V or less
10.00 μF		Approx.100 n/1 μ/10 μA	
100.0 μF		Approx.1 μ/10 μ/100 μA	
1.000 mF		Approx.10 μ/100 μ/200 μA	
10.00 mF		Approx.100 μ/200 μA	

Frequency	
Range	Accuracy
99.99 Hz	±0.1 %rdg. +2 dgt.
999.9 Hz	
9.999 kHz	

Safety	
Maximum rated voltage between input terminals and ground	CAT III 600V/ CAT IV300V
Maximum rated voltage between terminals	Between the V and COM terminals : 600 V DC/AC

Accessories

TEST LEAD DT4911 / Instruction Manual / LR03 Alkaline battery×1
Holster (attached to the instrument, with a test lead holder.)

L9207-10 / DT4911 Options

DT4280/DT4250 Series (Bundled accessory)

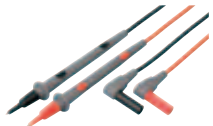

TEST LEAD L9207-10

Cable length 90 cm (2.9527 ft)
with one each red and black caps

with cap
CAT III 1000V/CAT IV 600V
without cap
CAT II 1000V

DT4220 Series (Bundled accessory)



TEST LEAD DT4911

Cable length 54 cm (1.77 ft)
with one each red and black caps

with cap
CAT IV 300V/ CAT III 600V
without cap
CAT II 600V

L4933 and L4934 probe tips
(at right) can be used
on L9207-10/DT4911 test leads.

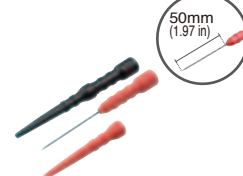
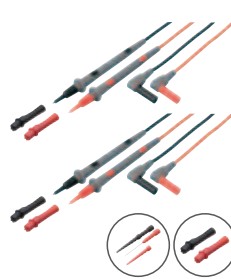

DC70V/AC33V
CONTACT PIN SET L4933



CAT II 600V
CAT III 300V
SMALL ALLIGATOR CLIP SET L4934

L4930 Options

Compatible DMMs: DT4250 Series / DT4280 Series



Length : 1.2m (3.937 ft)

CONNECTION CABLE L4930

Probe tips (at right) can be
used on L4930 connection
cables.

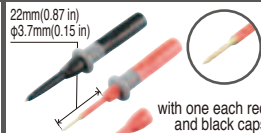

with one each red
and black caps
CAT III 600V (with cap)
CAT II 600V (without cap)
TEST PIN SET L4938



CAT III 1000V
CAT IV 600V
ALLIGATOR CLIP SET L4935

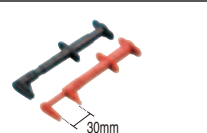

30mm
(1.18 in)
CAT III 600V
BUS BAR CLIP SET L4936



Magnet
φ6mm(0.24 in)

CAT III 1000V
MAGNETIC ADAPTER SET L4937

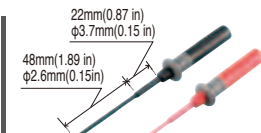

CAT III 600V
BREAKER PIN L4939

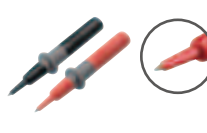

CAT III 1000V /CAT IV 600V
with one each red and black caps
TEST PIN SET L4932



CAT III 1000V
GRABBER CLIP 9243

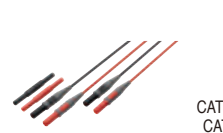

CAT III 1000V
CAT IV 600V
Length : 1.5m (4.9212 ft)
With coupling connectors
EXTENSION CABLE SET L4931

AC CLAMP ON PROBES for DT4281, DT4253, DT4255, DT4256 (Adapter 9704 required for connection)

Product appearance	CAT III 600V	CAT III 600V	CAT III 600V
Model number	9010-50	9018-50	9132-50
Rated current	AC 10/20/50/100/200/500 A		AC 20/50/100/200/500/1000A
Amplitude accuracy (45 to 66Hz)	±2% rdg. ±1% f.s.	±1.5% rdg. ±0.1% f.s.	±3% rdg. ±0.2% f.s.
Frequency characteristics	40Hz to 1kHz:±6% rdg.	40Hz to 3kHz:±1% rdg.	40Hz to 1kHz:±1% rdg.
Output rate	AC 0.2 V f.s. (For each range)		
Max. circuit voltage	AC600 V (50/60Hz)		
Diameter	φ46mm (1.81 in) or less	φ55mm (2.17 in) or less, 80x20mm (3.15x0.79 in)	
Dimensions, mass	78Wx188Hx35D mm (3.07W x 7.40H x 1.38D in) 420g (14.8oz.), cord length 3m (9.84 ft)	100Wx224Hx35D mm (3.94W x 8.82 H x 1.38D in) 600g(21.1oz.), cord length 3m(9.84 ft)	

Adapter Model 9704 is required to connect
AC CLAMP ON PROBES 9010-50, 9018-
50 and 9132-50 to the DT4281, DT4253,
DT4255, DT4256.



CONVERSION ADAPTER 9704

Other options



THERMOCOUPLES (K) DT4910

- Thermal junction form: exposed weld
- Sensor length: approx. 800 mm
- Measurement temperature range
-40 to 260°C
- Allowable tolerance:±2.5°C



COMMUNICATION PACKAGE (USB) DT4900-01

- Communication cable
- Communication adapter
- PC software
- Instruction manual
- OS: Windows 8.1/8/7, Vista
(SP1 or later)



MAGNETIC STRAP Z5004



CARRYING CASE C0200

DT4220 Series



CARRYING CASE C0202

DT4250/DT4280 Series



CARRYING CASE C0201

DT4250 Series



CARRYING CASE 3853

DT4250 Series

Note: Company names and Product names appearing in this catalog are trademarks or registered trademarks of various companies.

HIOKI

HIOKI E. E. CORPORATION

HEADQUARTERS

81 Koizumi, Ueda, Nagano, 386-1192, Japan
TEL +81-268-28-0562 FAX +81-268-28-0568
http://www.hioki.com / E-mail: os-com@hioki.co.jp

HIOKI USA CORPORATION

TEL +1-609-409-9109 FAX +1-609-409-9108
http://www.hioki.com / E-mail: hioki@hioki.com

HIOKI (Shanghai) SALES & TRADING CO., LTD.
TEL +86-21-63910090 FAX +86-21-63910360
http://www.hioki.cn / E-mail: info@hioki.com.cn

HIOKI INDIA PRIVATE LIMITED

TEL +91-124-6590210
E-mail: hioki@hioki.in

HIOKI SINGAPORE PTE. LTD.

TEL +65-6634-7677 FAX +65-6634-7477
E-mail: info-sg@hioki.com.sg

HIOKI KOREA CO., LTD.

TEL +82-2-2183-8847 FAX +82-2-2183-3360
E-mail: info-kr@hioki.co.jp

DISTRIBUTED BY