

EK-3030 Temperature Controller User Manual

General:

This controller is suitable for temperature control of the middle and low temperature cold storage. It could measure, display and control temperature, with the function of temperature calibration, forced defrost and temperature over temperature alarm and sensor failure alarm, one key recovery of the factory default value, parameters preset and one key recovery. It adopts touch key design with the key lock function.

Dual-way sensor input: cabinet temperature sensor(Pb1) and defrost sensor(Pb2). Three way control output: Refrigeration, defrost and fan.

Features:

- ◆ Six touch key design, quick parameter setting, easy operation.
- ◆ Multiple defrost control modes, more stable and energy saving, avoid cold storage swell.
- ◆ Defrost cycle power off memory function.
- ◆ Construction contractor could preset a group of parameters, with one key recovery function.
- ◆ Three work modes: Refrigeration mode, heating mode and constant temperature mode.

Technical parameters:

- 1) Measuring range: -40℃~99℃
- 2) Controlling range: -40℃~85℃;
- 3) Accuracy: -30℃~50℃, ±1℃±0.5dig; others, ±2℃±0.5dig
- 4) Resolution: 0.1℃ / 1℃
- 5) Mounting size: 71mm*29mm
- 6) Power supply: 220VAC±10%, 50/60Hz
- 7) Power consumption: <5W
- 8) Output capacity:
Refrigeration: 10A/220VAC (or 16A/220VAC directly drive a single phase compressor 1HP)
Defrost: 10A/220VAC
Fan: 10A/220VAC
One way buzzer alarm output
- 9) Work ambient temperature: -5℃~60℃; work ambient humidity: 10%~90% non condensing
- 10) Storage temperature: -25℃~75℃
- 11) Sensor type: NTC (10KΩ/25℃, B value 3435K)
- 12) Sensor length: 2M

1.Operation and display panel



Display panel can display three digits, two status indicator (key lock and fan), four parameters descriptors (On temp , Off temp , Def time , Def cycle) .

Under normal running status, all descriptors will not light; when enter the menu setting mode, the corresponding parameter descriptor lights. Under normal running status, if there is refrigeration/heating output, "On" descriptor lights; if defrost runs, "Def" descriptor lights.

2.Indicator light status description

Indicator light	Symbol	Statu	Meaning
Key lock		OFF	Unlocked status
		ON	Key lock status
Refrigeration / Heating	On	ON	Refrigeration work
		OFF	Refrigeration stop
		FLASH	Refrigeration time delay

Indicator light	Symbol	Statu	Meaning
Defrost		OFF	Defrost stop
		Flash(slowly)	Defrost delay
		Flash(quickly)	Defrost dripping
		On	Defrost work
Fan		ON	Fan work
		FLASH	Fan delay
		OFF	Fan stop

3. Key description

There are in total six keys in the controller:

- ☼ : forced defrost key; "On Temp"; " Off Temp";
- ▲ : UP key; ▼ : DOWN key; ⏹/OK : unlock/OK key;

Operation instruction:

1. Controller locking and unlocking

Under the status of controller locking, press ⏹/OK for one second, the controller will be unlocked, and at the same time, the buzzer beeps for about 0.5second. If no key operation within 30seconds, the controller will lock automatically.

2. User menu setting

Under the normal running status, press "On Temp" (or "Off Temp") , the corresponding parameter descriptor lights, and it displays the value of "On Temp" (or "Off Temp") in the display window, which indicating that it has entered to the setup menu of "On Temp" (or "Off Temp"). The parameters could be adjusted by pressing the keys "▲" or "▼", and if the keys "▲" or "▼" is kept pressed, the parameters could be adjusted quickly. In the setting mode, press and release the key ⏹/OK or no key operation within 30seconds, it will exit from setting mode and save the parameters.

Parameter descriptor	Description	Setting range	SetDefault setting	Work mode	Note
On Temp Descriptor lights	Compressor start temperature	Off Temp ~+85.0 C	10.0 C	Refrigeration	If cabinet temperature is higher than set temperature, refrigeration starts.
Off Temp Descriptor lights	Compressor shutdown temperature	-40.0 C ~ Temp On	-10.0 C	Refrigeration	If cabinet temperature is lower than set temperature, refrigeration closes.

3. System menu setting

Under the normal running status, press ⏹/OK for more than 5seconds, and it will display parameter code "F1" in the temperature display window, which indicating that it has entered to the system setup menu. The parameter codes could be switched by pressing the keys "▲" or "▼", and press and release ⏹/OK to display the corresponding parameter values. The parameter could be adjusted by pressing the keys "▲" or "▼", and if the keys "▲" or "▼" is kept pressed, the parameters could be adjusted quickly. Press and release the key ⏹/OK to save the modified parameter value and return to display parameter code.

In System menu setting status, press the key ⏹/OK for 5seconds or no key operation within 30seconds, it will save the parameters and exit from system menu setting status.

If an error occurs when you save the parameters, it shows "Err" in the temperature display window, and it returns to the normal display status in 5 seconds.

In System setting status, press and hold "☼" key for more than 5 seconds, it will blinkingly display password setting. The hide menu is unavailable to access until a correct password is set. The password fixed value is "-15". Under System menu, press ⏹/OK key for 5 seconds, or no key operation within 30 seconds, it will exit from system setting menu, and it will save the parameters .

Parameters	Description	Setting range	Default value	Note
F1	Defrost time	1~120 Min	30 Min	Duration time during defrost
F2	Defrost cycle	0~120 Hour	6 Hour	The interval during two defrosts (Auto record every one hour)

Parameters	Description	Setting range	Default value	Note
F3	Defrost cycle calculation	0: Cumulative controller work time after power on 1: Cumulative compressor work time after power on	1	
F4	Dripping time after defrost	0~120min	3min	Time delay after finishing defrost
F5	Defrost type	0: Electric heating defrost 1: Hot gas defrost 2: wind defrost	0	Before hot gas defrost, the compressor stops for 3minutes then start defrost, to make sure the reliability of the system. After hot gas defrost, compressor starts after 2 minutes time delay.
F6	Defrost termination temperature	-40.0℃~+50.0℃	10℃	If defrost sensor temperature is high than the set value, defrost stops and defrost is forbidden. Note: if H8=0, this parameter will be disabled.
F7	Fan running mode	-180~-1: Fan starts ahead of compressor 180~1(second) 0: Fan and compressor run synchronically c: Fan runs continuously (no time delay after dripping) d: Fan runs continuously, stops during defrost and dripping 1~300: Fan starts behind compressor 1~300 (seconds)	0	Valid under Fan Controlled Mode(H10=0) Note: If H10=1or H10=2, this parameter item is disabled.
F8	Initial fan start time delay after dripping	0~300S	30S	Initial fan start time delay after dripping
F9	Compressor start time delay	0~10Min	0	Compress start minimum time interval from its last stop (include the compressor start time delay for the initial power on)
F10	Over temperature alarm time delay after power on	0~24.0Hour	2.0Hour	After power on, during this time range, there is no over temperature alarm signal
F11	Over temperature alarm	0~50.0℃	5.0℃	Refrigeration mode: If cabinet temperature is higher than "Temp On value + Over temperature alarm value" or lower than "Temp Off value-over temperature alarm value", it alarms.
F12	Over temperature alarm time delay	0~120Min	10Min	Alarm won't occur until over temperature duration is longer than this parameter.

Parameters	Description	Setting range	Default value	Note
F13	Temperature calibration of cabinet sensor	-10.0℃~+10.0℃	0.0℃	When the measured cabinet temperature has an error, temperature could be calibrated by this parameter.
Hide Menu:				
H1	Compressor stop time in the mode of "Run/stop in a proportional time"	1~60Min	30Min	Compressor stop time during when cabinet sensor fails.
H2	Compressor start time in the mode of "Run/stop in a proportional time"	0~60Min	15Min	Compressor start time during when cabinet sensor fails.
H3	Cabinet temperature upper limit alarm value	Cabinet temperature lower limit alarm value~85.0℃	20.0℃	Note: If H5=1, this parameter item will be disabled.
H4	Cabinet temperature lower limit alarm value	-40.0℃~Cabinet temperature upper lower limit alarm value	-20.0℃	Note: If H5=1, this parameter item will be disabled.
H5	Over temperature alarm mode	0: Absolute temperature 1:Temp On/Off value ± Over temperature alarm value	1	
H6	Start buzzer alarm	0: No 1: Yes	1	Buzzer beeps or not during alarm
H7	Display mode during defrost and dripping	0:Normal cabinet temperature 1:Display dEF 2: Display start-defrost cabinet temperature	0	Note: If the cabinet temperature reaches start-defrost-temperature within 15minutes after defrost dripping, it displays real-time cabinet temperature.
H8	Start evaporator sensor	0: No 1: Yes	1	
H9	Temperature calibration of defrost sensor	-10.0℃~+10.0℃	0.0℃	When the measured cabinet temperature has an error, temperature could be calibrated by this parameter. Note: if H8=0, this parameter is disabled.
H10	Fan controlled mode	0: Fan is controlled by compressor time 1: Fan is controlled by defrost sensor temperature 2: Fan is controller by the temperature difference between cabinet sensor and defrost	0	Note: if H8=0, this parameter is disabled.

Note: H14—work mode

The controller could select the work modes as below:

Refrigeration is realized by compressor; Heating and Constant temperature mode are realized by defrost device. Thee detailed logical relation is as below:

	Compressor control	Defrost control		Fan control
		Electric-heating defrost	Hot gas defrost	
0: Refrigeration	The controller controls the start/stop of compressor according to the parameter "On Temp" and "Off Temp"	The controller controls the start/stop of defrost device according to the parameter "def cycle" and "def time".		The controller controls the start/stop of fan according to Fan controlled mode
1: Heating	In hot gas defrost, compressor starts; In electric-heating defrost, compressor doesn't work.	Note: If heating is realized by heater(electric-heating), there is no defrost function.	Note: If heating is realized by hot gas theory, defrost is realized by controlling the start/stop of defrost device according to "Defrost cycle" and "Defrost time".At this time, condenser is in the status of defrost, therefore, "defrost termination temperature" is invalid.	Fan runs continuously, stops during defrost and dripping
2: Constant temperature	Integrated the function of refrigeration and heating, execute the corresponding refrigeration or heating function in each phase.	After refrigeration, if the calculation of "defrost cycle" is not finished, and it starts heating, then the timer of "defrost cycle" and "defrost time" is cleared. After refrigeration, if there is no heating proceeded, and it finishes the calculation of "defrost cycle", then it starts defrost. Note: The defrost function takes priority over refrigeration and heating function.	Note 1: During refrigeration, if finish "defrost cycle", then it begins hot gas defrost on the evaporator. During heating, if finish "defrost cycle", then it begins hot gas defrost on the evaporator. Note 2: During the switch	During refrigeration: the controller controls the start/stop of fan according to fan controlled mode. During heating: Fan and heater run/stop synchronically,

			between refrigeration and heating, the timer of "defrost cycle" will be cleared and it will start timing again.	synchronically, stop during defrost and dripping.
--	--	--	---	---

4. Manual defrost

In the status of non-defrosting, non-defrost-dripping, non-parameter setting, and defrost cycle is not set to 0 and the defrost sensor temperature is less than the set defrost termination temperature (F6), press  key for more than three seconds, it enters to manual defrost status, and the defrost working indicator lights and start defrosting.

In the defrost status (non-parameter setting status), press  key for more than three seconds, it exits from defrost status, and the defrost working indicator flashes, defrost stops and start defrost dripping.



5. View defrost sensor temperature

Under the normal running status or lock status, press  key, it displays defrost sensor temperature in the temperature display window. Release the key, it returns to the normal display status.

6. Buzzer alarm mute

Press any key to eliminate the alarm buzzer beeping, but the alarm indicator light will not be off until the alarm is released.

7. One key recovery of factory parameters

In the key lock status, press the "" key for more than 10 seconds, then display "rES" for 3 seconds, within these three seconds, press  key to recover the parameters to the factory default values, and it displays "YES". If an error occurs during the parameters saving, display "Err" in the temperature display window, and in 3 seconds, it is in the normal display. It is recommended at this time to re-energize the controller.

8. Parameter preset and one key recovery

In the key lock status, press "On Temp" key for more than 10 seconds, it displays "COP" for 3 seconds, within these three seconds, press  key to copy the current parameter setting as the factory preset data, and it displays "YES", so that end-users could recover the controller parameters to the appropriate setting in case of emergency.

In the key lock status, press "Off Temp" key for more than 10 seconds, it displays "don" for 3 seconds, within these three seconds, press  key to recover to the factory preset parameter setting and it displays "YES", It is recommended at this time to re-energize the controller.

Note 1: Before recovering to factory preset parameter setting, to make sure that the parameters have previously backed up. Otherwise, it will recover to the factory default parameters.

Control output

1) Refrigeration control:

Normal status: When the cabinet temperature is higher than "On Temp" value, compressor starts; when the cabinet temperature is lower than "Off Temp" value, compressor stops.

Compressor startup condition (meet all the condition as below):

- Compressor stop time exceeds the set compressor time delay;
- Fan start time ahead of compressor meets the set time (Fan start time ahead of compressor is set as minus)
- When cabinet temperature \geq "On Temp" value or during hot gas defrost (In non-defrost and non-defrost -dripping status).

Compressor close condition (meet any of the conditions as below):

- Cabinet temperature \leq "Off Temp" value;
- When start electric-heating defrost;
- When hot gas defrost stops;

2) Defrost control

Defrost startup condition (meet all the condition as below):

- Defrost cycle is not set as 0;
- Defrost sensor temperature is lower than the set defrost termination temperature;
- Finish the set "defrost cycle", or forced defrost starts.

Defrost close condition: It is controlled by both temperature and time. After start defrosting, if defrost sensor temperature reaches "defrost termination temperature", then defrost finishes and stop defrost. If defrost time is too long and exceeds "defrost time", the controller will also stop defrost. If neither temperature nor time reaches the set value, it could exit from defrost status through manually pressing the key of "forced defrost".

Defrost dripping time: The purpose of defrost dripping is to discharge the water accumulated during defrost in the evaporator. If the water could not be discharged timely, the water will be frozen again during refrigeration.

Therefore, it is necessary to set a defrost dripping time to make sure a timely water discharge during defrost. During this period, the compressor does not start, and " defrost " working status indicator flashes at this time.

3) Fan control

Fan has three controller modes(parameter H10) :

- 0: Fan is controlled by compressor time
 - 1: Fan is controlled by defrost sensor temperature
 - 2: Fan is controller by the temperature difference between cabinet sensor and defrost sensor
- For these three modes, they are conflicting with each other, only one mode could be selected.

- H10=0: Fan is controlled by compressor time
- 180~-1: Fan starts ahead of compressor 180~1S
- 0: Fan and compressor run synchronically
- c: Fan runs continuously
- d: Fan runs continuously, stops during defrost and dripping
- 1~300: Fan starts behind compressor 1~300S

H10=1: Fan is controlled by defrost sensor temperature
H11: Fan start temperature

It is valid when Fan controlled mode = 1, when the defrost sensor temperature is lower than this value, the fan start working, and it stops during defrost and dripping; after finishing defrost dripping, the function of F8 is invalid. If the defrost sensor fails, fan runs continuously and it stops during defrost and dripping; after finishing dripping, the function of F8 is valid.

H12: Fan stop Temperature:

It is valid when Fan controlled mode = 1, when the defrost sensor temperature is higher than this value, the fan stops working, and it stops during defrost and dripping; after finishing defrost dripping, the function of F8 is invalid. If the defrost sensor fails, fan runs continuously and it stops during defrost and dripping; after finishing dripping, the function of F8 is valid.

H10=2: Fan is controller by the temperature difference between cabinet sensor and defrost sensor

H13: Fan start temperature difference:

It is valid when Fan controlled mode = 2, when cabinet temperature value – evaporator sensor temperature value > H13, the fan starts working, and it stops during defrost and dripping; after finishing defrost dripping, the function of F8 is invalid. If the cabinet sensor or defrost sensor fails, fan runs continuously and it stops during defrost and dripping; after finishing dripping, the function of F8 is valid.

4) Alarm output

The controller has one way buzzer alarm output. In the running status, when the following conditions occur, the buzzer beeps:

- When the cabinet sensor fails, it displays the fault code E1 in the temperature display window; the controller will run in the fixed pattern: the compressor stops for 30 minutes, then runs for 15 minutes. After cabinet sensor failure is released, it enters to the normal temperature control mode and exits from the fixed compressor start/stop mode.
- Defrost sensor fails, it alternately displays the fault code E2 and the current cabinet temperature in the temperature display window; the controller controls according to the set defrost cycle and defrost time. When the defrost sensor failure is released, it enters to the dual-control mode by both time and temperature.
- If the cabinet sensor and defrost sensor fail simultaneously, it alternately displays the fault code E1 and E2 in the temperature display window;
 - When cabinet temperature \geq " On Temp value" + " over temperature alarm value" (H5 = 1) and the duration \geq " temperature alarm time delay " and " Over temperature alarm time delay after power on " , high temperature alarm occurs, it alternately displays the current cabinet temperature and the fault code HA in the temperature display window. When cabinet temperature < " On Temp value" + " over temperature alarm value", high temperature alarm is canceled. When H5=0, it works in the same way.
 - When cabinet temperature \leq " Off Temp value" - " over temperature alarm value" (H5 = 1) and the duration \geq " temperature alarm time delay " and " Over temperature alarm time delay after power on " , low temperature alarm occurs, it alternately displays the current cabinet temperature and the fault code LA in the temperature display window. When cabinet temperature > " Off Temp value" - " over temperature alarm value", low temperature alarm is canceled. When H5=0, it works in the same way.

Wiring diagram

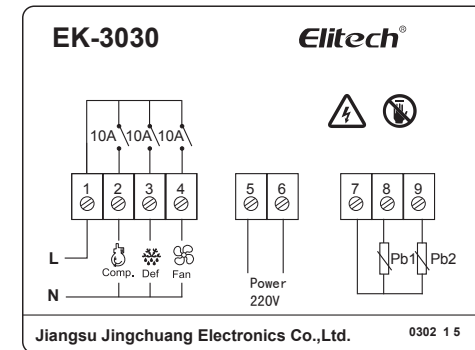

Safety rules:

★Danger:

1. Strictly distinguish the power wire, relay output, sensor down-lead and data line, and the relay could not be overloaded.
2. Prohibit connecting the wire terminals without electricity cut-off.

★Warning:

Prohibit using this unit under the environment of over damp, high temp., strong electromagnetism interference or strong corrosion.

★Notice:

1. The power supply should conform to the voltage value indicated in the instruction, and make sure a steady power supply.
2. To avoid the possible interference, the sensor down-lead/data line and power wire should be kept in a proper distance.
3. When evaporator sensor is installed, the sensor should be well connected with the copper tube which is 5cm away from evaporator inlet.