

# Elitech<sup>®</sup>



**Electrical board for small  
and medium size cold storage**



#### **General descriptions:**

ECB-1000Q is widely used for the small and medium size cold storage, with the function of refrigeration, defrost, fan, light control, alarm and time display.

#### **Features:**

- Big screen, blue digital tube, show all necessary information
- Directly drive single-phase compressor 3HP
- LED status indicator light
- Password protection, avoid misoperation by personnel
- Real-Time Clock, could display time and control defrost
- Forced defrost function
- Night saving function

### Technical parameters:

Power Supply: 220VAC±10%,50/60Hz      Power Consumption: Less than 5W  
Temperature Measuring Range: -45℃~99℃      Accuracy: ±1℃  
Temperature Controlling Range -40℃~90℃      Resolution: 0.1℃/1℃ or 1F  
Relay Capacity :  
Compressor 50A/240VAC      Max. capacity of controlling the compressor: 3P  
Defrost      8A/220VAC  
Fan      5A/220VAC      Max. capacity of controlling the fan: 500W  
Light      5A/220VAC      Max. capacity of controlling the light: 300W  
Alarm      5A/220VAC  
Storage Temperature: -20℃~75℃      Work Temperature: -5℃~60℃  
Sensor Type: NTC(10KΩ/25℃,B-3435K)

### Introduction of indicator light

❄	Refrigeration	On: Refrigerating	Flash: Refrigeration delay	Off: Refrigeration stop
🌀	Fan	On: Fan working	Off: Fan stop	
☀	Light	On: Light on	Off: Light off	
❄	Defrost	On: Defrosting	Off: Defrost stop	
🚨	Alarm	On: System alarm	Off: No alarm	
🌙	Energy saving	On: Night saving mode	Off: Normal mode	

### Parameter list:

	Parameter	Introduction	Range	Default Value
<b>Temperature Setting Operation</b>				
		Temperature Control Setting Point	(-50...100)℃	0
<b>Parameter C</b>				
1	C01	Differential	(0.1 ... 20.0) K	2.0
2	C02	Max set point limit	(C03 ... 100)℃	100.0
3	C03	Min set point limit	(-50.0 ... C02)℃	-50.0
4	C04	Min. ON-time	(0 ...15)Min	0
5	C05	Min. OFF-time	(0 ...15)Min	0
6	C06	Temperature calibration	(-12.0...12.0)℃	0.0
7	C07	Compressor On delay after Power On	(0 ...30)Min	2
8	C08	Night-Saving Function(1: On, 2: Off)	(1 ...2)	2
9	C09	Night-time start hour	(0 ...23)hour	22
10	C10	Night-time start minute	(0 ...59)min	0
11	C11	Night-time close hour	(0 ...23)hour	8
12	C12	Night-time close minute	(0 ...59)min	0
13	C13	Night set back differential	(0 ...10)K	2

<b>Parameter A</b>				
	Parameter	Introduction	Range	Default Value
14	A01	High temperature alarm(tem.+C01+A01)	(0 ...30)K	10
15	A02	Low temperature alarm(tem.-A02)	(0 ...30)K	10
16	A03	Alarm differential	(1...10)K	2
17	A04	Alarm time delay	(0 ...99)min	30
18	A05	Alarm time delay after defrost end and power-on	(0 ...99)min	20
19	A06	Buzzer keeps silent when alarm occurs(1: On, 2: Off)	(1 ...2)	1
20	A07	Door open alarm time delay	(0 ...99)min	30
<b>Parameter D</b>				
21	d01	Defrost type (1:electric heater 2. Hot gas)	(1 ...2)	1
22	d02	Defrost end function (1: temperature sensor termination, 2: defrost time termination)	(1 ...2)	1
23	d03	Defrost stop temperature (if d02=1)	(0...99)°C	8
24	d04	Defrost interval time	(0 ...48)hour	6
25	d05	Max-defrost duration	(0 ...99)min	30
26	d06	Dripping time	(0 ...20)min	2
27	d07	First defrost delay after power-on	(0 ...99)min	0
28	d08	Max-times of defrost every day (if 003=2)	(0 ...7)	0
29	d09	Defrost sensor calibration	(-12.0...12.0)°C	0
<b>Parameter F</b>				
30	F01	Fan operation function (1:Always on; 2:Parallel to compressor)	(1 ...2)	1
31	F02	Fan stop during defrost (1:Yes; 2:No)	(1 ...2)	1
32	F03	Fan start temperature after defrost	(-30...5)°C	5
33	F04	Fan start-up delay after defrost	(0 ...10)min	3
<b>Parameter O</b>				
34	o01	Sensor error, compressor functioning (1:On, 2:Off)	(1 ...2)	1
35	o02	Access Password	(0 ...999)	0
36	o03	Defrost start mode(1:by Internal timer; 2:by Real Time Clock Module)	(1 ...2)	1
37	o04	Display decimal(1:Yes; 2:No)	(1 ...2)	1
38	o05	Digital input definition (1:None; 2-5:Door switch)	(1 ...5)	1
39	o06	Temperature display in °C or °F (1:°C; 2:°F)	(1 ...2)	1

Parameter T				
	Parameter	Introduction	Range	Default Value
40	t01	1st defrost start hour	(0 ...23)hour	0
41	t02	1st defrost start minute	(0 ...59)min	0
42	t03	2nd defrost start hour	(0 ...23)hour	0
43	t04	2nd defrost start minute	(0 ...59)min	0
44	t05	3rd defrost start hour	(0 ...23)hour	0
45	t06	3rd defrost start minute	(0 ...59)min	0
46	t07	4th defrost start hour	(0 ...23)hour	0
47	t08	4th defrost start minute	(0 ...59)min	0
48	t09	5th defrost start hour	(0 ...23)hour	0
49	t10	5th defrost start minute	(0 ...59)min	0
50	t11	6th defrost start hour	(0 ...23)hour	0
51	t12	6th defrost start minute	(0 ...59)min	0
52	t13	7th defrost start hour	(0 ...23)hour	0
53	t14	7th defrost start minute	(0 ...59)min	0
<b>Error code display</b>				
E1		<b>Short-circuited room sensor</b>		
E2		<b>Disconnected room sensor</b>		
E3		<b>Disconnected defrost sensor</b>		
E4		<b>Short-circuited defrost sensor</b>		
E5		<b>High temperature alarm</b>		
E6		<b>Low temperature alarm</b>		
E7		<b>Door open alarm</b>		

### Parameter Description

#### C-Temperature Control Parameters Group

##### C01-Differential

This is the difference between the temperature at which the cooling output is switched off and the temperature at which the output is switched on. This is an absolute value related to the set point. It switched on when temperature goes over set point temperature +C01, and is turned off when the temperature decreases to set point temperature.

##### C02-Max set point limit

The set point value cannot be adjusted outside the limits defined by these parameters to avoid improper set point setting by the user

##### C03-Min set point limit

The set point value cannot be adjusted outside the limits defined by these parameters to avoid improper set point setting by the user

##### C04-Min.ON-time

The value that you set is for how long the cooling is to run once it has been started

##### C05-Min.OFF-time (anti short cycle)

The value is the minimum time between two subsequent switches on of the output

##### C06- Temperature calibration

Correct of the sensor error. Display temperature equal to measuring temperature of the actual value and the numerical C06.

##### C07-Compressor On delay after Power On

This value is designed for avoiding cooling output is switched on immediately when controller gets power, it should be power on after C07

### **C08-Night-Saving Function**

This parameter determines the Night-Saving function on or not

### **C09-Night-time start hour**

This value determines the time in Hour for the beginning of night-time

### **C10-Night-time start minute**

This value determines the time in Minute for the beginning of night-time

### **C11-Night-time close hour**

This value determines the time in Hour for the end of night-time

### **C12-Night-time close minute**

This value determines the time in Minute for the end of night-time

### **C13-Night set back differential**

This value is designed to raise the temperature setting during night-time period in order to save energy

## **A-Alarm Parameter Group**

### **A01-High temperature alarm**

High temperature alarm value relative to set point

E.g. If your set point is at 4, differential C01=2, and A01=5, the alarm will be triggered at 11

### **A02-Low temperature alarm**

Low temperature alarm value relative to set point

E.g. If your set point is at 4, and A02=3, it will be triggered at 1 and cancel at 4

### **A03-Alarm differential**

Useful to avoid alarm oscillation

Example: Set point=4, C01=2, A01=6, A03=2; In this case when the cold room temperature exceeds  $4+C01+A01 = 4+2+6=12$  for a time greater than parameter A04 the alarm is activated when temperature drops below  $4+C01+A01-A03 = 4+2+6-2=10$ , the alarm is reset

### **A04-Alarm time delay**

Delay between the detection of the temperature alarm and the activation of the alarm sequences. This is useful to prevent temporary conditions from causing an alarm

### **A05-Alarm time delay after defrost end and power-on**

Time the controller should automatically ignore the temperature alarm condition after defrost end and power-on

### **A06-Buzzer keeps silent when alarm occurs**

You can select audible alarm by this parameter

### **A07-Door open alarm time delay**

Delay between the detection of the door opens and the activation of the alarm sequences. This is very useful to prevent cold room losing efficiency if the door is not closed completely

## **d-Defrost Parameter Group**

### **d01-Defrost type**

Select the type of your installation and the way defrost is performed

1:electric defrost; 2:hot gas defrost

### **d02-Defrost end function**

Select the defrost termination type by temperature or by time

### **d03-Defrost stop temperature**

This parameter determines the achieve temperature to stop defrost

### **d04-Defrost interval time**

This is the time between two subsequent defrost cycles. This timer will initiate every defrost cycle

### **d05-Max-defrost duration**

The defrost cycle will stop after this time even if the defrost end temperature has not been reached

#### **d06-Dripping time**

After defrost is terminated the compressor or cooling valve is stopped to allow the evaporator to drip

#### **d07-First defrost delay after power-on**

This parameter allows to delay a defrost cycle after power-on. This will prevent a cycle from occurring before the cold room has reached its operations temperature

#### **d08-Max-times of defrost every day(if 003=2)**

This parameter defines how many times is needed for fixed defrost by RTC each day

#### **d09-Defrost sensor calibration**

Correct the sensor error. Display temperature equal to measuring temperature of the actual value plus d09 value

### **F-Fan Control Parameter Group**

#### **F01-Fan operation function**

This parameter determines the fan work mode

#### **F02-Fan operation during defrost**

This parameter determines the fan work or not during defrosts

#### **F03-Fan start temperature after defrost**

This parameter determines the temperature when the fan start work after defrost

#### **F04-Fan start-up delay after defrost**

This parameter determines the delay time of fan then it work after defrost

### **o-Other Parameter Group**

#### **o01- Sensor error, compressor functioning**

This parameter determines when the sensor error occurs, compressor turns on/off with proportional time

#### **o02-Access Password**

This allows to protect all the setting in the controller by an access code

#### **o03-Defrost start mode**

This parameter allows you to choose defrost start mode

#### **o04-Display decimal**

This parameter allows you to choose temperature display with or without decimal

#### **o05-Digital input definition**

None or Door Switch

When door opens-evaporator's fan stops automatically

When door closes-evaporator's fan runs automatically

#### **o06-Temperature display in °C or °F**

This parameter determines displayed temperature in °C or °F

### **t-Time schedule of defrost by Real Time Clock**

#### **t01-1st defrost start hour**

This value determines the time in Hour of the 1st defrost generation every day

#### **t02-1st defrost start minute**

This value determines the time in Minute of the 1st defrost generation every day

#### **t03-2nd defrost start hour**

This value determines the time in Hour of the 2nd defrost generation every day

#### **t04-2nd defrost start Minute**

This value determines the time in Minute of the 2nd defrost generation every day

### t05-3rd defrost start Hour

This value determines the time in Hour of the 3rd defrost generation every day

### t06-3rd defrost start Minute

This value determines the time in Minute of the 3rd defrost generation every day

### t07-4th defrost start Hour

This value determines the time in Hour of the 4th defrost generation every day

### t08-4th defrost start Minute

This value determines the time in Minute of the 4th defrost generation every day-

### t09-5th defrost start Hour

This value determines the time in Hour of the 5th defrost generation every day

### t10-5th defrost start Minute

This value determines the time in Minute of the 5th defrost generation every day-

### t11-6th defrost start Hour

This value determines the time in Hour of the 6th defrost generation every day

### t12-6th defrost start Minute

This value determines the time in Minute of the 6th defrost generation every day

### t13-7th defrost start Hour

This value determines the time in Hour of the 7th defrost generation every day

### t14-7th defrost start Minute

This value determines the time in Minute of the 7th defrost generation every day

## Configuration Chart

### Set point: (no need password )

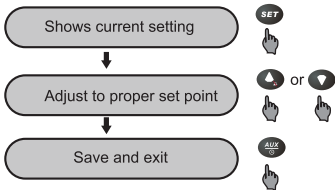

### Forced defrost :( no need password )

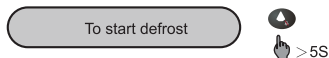



### Change parameter:

if o02=0, then

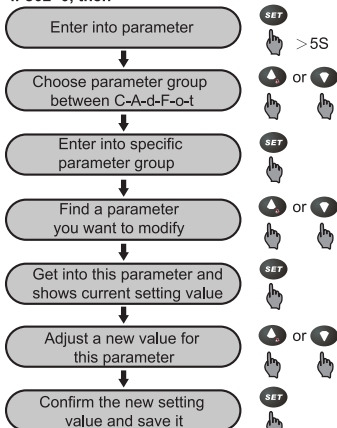

### Switch ON/OFF: ( no need password)

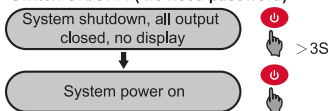

### Time setting: (no need password)

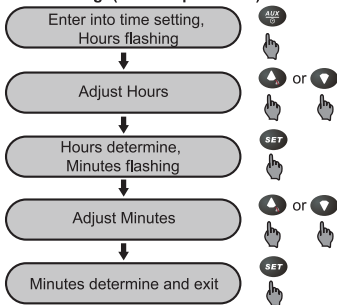

if o02≠0, then

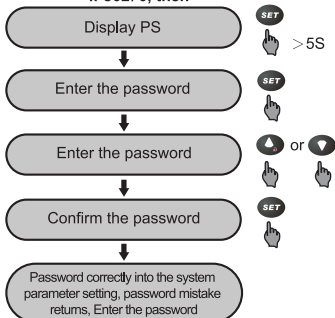

### Light control:( no need password)

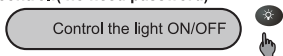

### others:

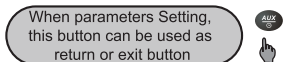

### View Defrost temperature :

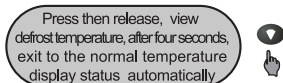

Note: When the parameter o05=2 , if the door switch is open, there is no effect on the compresses, and the fan stopped, light is on, the lighting is controlled by the light control button; if o05=3, light is only controlled by the door switch, not controlled by the lighting control button, the compressor and fan will not be affected ; if o05 = 4, when door is open , the compressor and the fan stops, the light is controlled by the door switch not by the light button control; If o05 = 5, when the door is open, the compressor and the fan are not affected, the light is on when door is open and it also can be controlled by the lighting control button

### Wiring diagram:

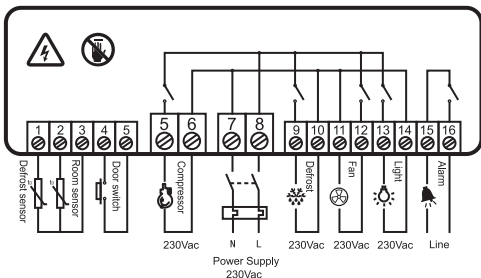

### Dimension(mm)

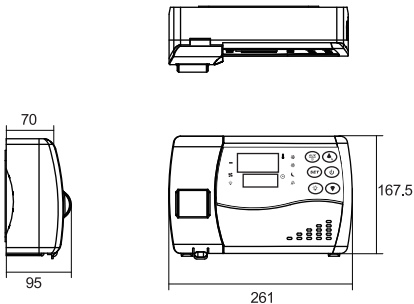

## Installation diagram

Step 1 : Open the left and right cover



Step 2 : Remove the four screws on the front shell



Step 3 : Remove the front panel



Step 4 : Fix the back shell according to the schematic diagram, and install rubbing pad

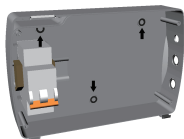

Step 5 : wiring and instal water joint

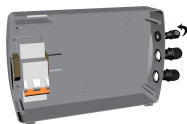

Step 6 : Fix the front and back shell

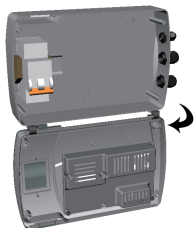

**Exploded drawing**

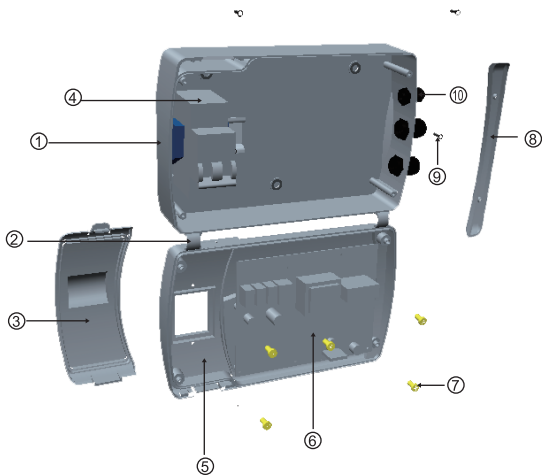

1	Back Shell
2	Hinge
3	Left Cover
4	Circuit Breaker
5	Front Shell
6	Circuit Board
7	Circuit Board Set Screw
8	Right Cover
9	Front Shell Set Screw
10	Water Joint

**Note:** There is a parameter o06 in the system, and the factory default setting is o06 = 1, the temperature will display in Celsius. If o06 = 2, the temperature will display in Fahrenheit.

